

**VOGLAUER**

**Dalpin**



# MODELS REGISTER

(valide from July 2015)

Please always indicate the following specifications:

**MODEL:** V-Alpin **AL**

**TYPE OF WOOD:**



Oak / Reclaimed oak wood EA

**LIGHTING:**



LED-light with switch LS



LED-light remote switch LF

**ACCENT FRONT: LODEN**

(Indicate loden number and description)

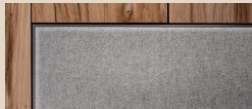

grauweiß MG



basaltgrau MB

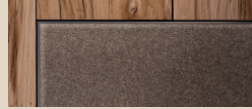

tundrabraun MT

**ACCENT FRONT: SATIN GLASS**

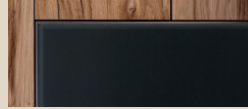

anthrazit A-

**LODEN (fabric for upholstery):** (Indicate loden number and description)



grauweiß MG

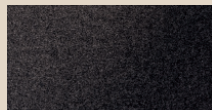

basaltgrau MB



tundrabraun MT

**LEATHER (fabric for upholstery):** (Indicate leather number and description)



sahne LW



ziegelrot LY

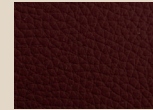

burgundy LX

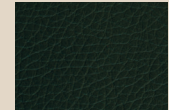

army green LZ

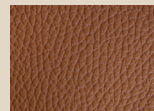

cognac LV

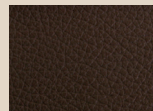

café LU

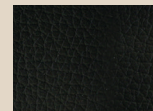

testa di moro LT

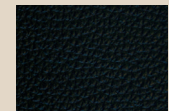

schwarz LS



kiesel LK



coco LO

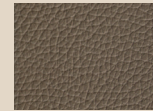

stone LM



cenere LP

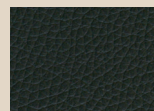

anthrazit LN

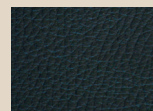

oceano LL

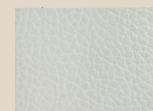

reinweiß LR

The colour samples are not suitable as color samples.

**REFERENCE NUMBER:**

Please indicate each article by its reference number.

Attention: Indicate article-specific complements!

**Ordering example:**

**AL19A-MG-R** Lowboard 192/34, 1 Hatch, 1 Drawer,  
Drawer with accent right, Cover material accent MG Loden  
grey-white, B/T/H 192/55/34 cm

**A-K**

Cable management

**A-S12**

Drawer 128 instead of hatch

**AV64G-R**

Vitrine 64, 1 Door, Doorstop right,  
B/T/H 64/42,3/194 cm

**A-LS4**

Lighting per switch

**AB20 LT**

Seating bench rounded 207 cm, avec leather  
LT testa di moro, B/T/H 206,5/69,6/84 cm

**ORDER MANAGEMENT AND TECHNICAL SUPPORT: Fax Nr.: +43 (0) 6243 2700 - 359**



**Daniel WALLINGER**

Tel. +43 (0) 6243 2700-355  
daniel.wallinger@voglauer.com



**Andreas FEISER**

Tel. +43 (0) 6243 2700-352  
andreas.feiser@voglauer.com



**Theresa WINTERSTELLER**

Tel. +43 (0) 6243 2700-377  
theresa.wintersteller@voglauer.com



**Michael RESCHREITER**

Tel. +43 (0) 6243 2700-357  
michael.reschreiter@voglauer.com



**Andrea GSENGER**

Tel. +43 (0) 6243 2700-450  
andrea.gsenger@voglauer.com

**DELIVERY DATE INFORMATION: Fax: +43 (0) 6243 2700 - 315**

**Delivery:** 5-7 weeks after having obtained commission

Helmut POSCH: helmut.posch@voglauer.com

Johann STEINER: johann.steiner@voglauer.com

**VOGLAUER – CERTIFICATIONS AND AWARDS**



## Structural Design / Loading Capacities:

Corpus:	Corpus parts blockboard veneered with genuine wood		
Fronts and Cover Panels:	blockboard veneered with genuine wood (oak matured timber brushed) edged in cross-grained wood		
Accent:	Loden oder Color glass anthracite (Glass satined 3 mm, back side RAL 9011 varnished)		
Shelf rows:	Wooden shelf rows behind wooden doors, bronzed glass shelf rows behind transparent front glasses (Parsol bronze 8 mm).		
Transparent front glasses and glass boards:	in ESG (toughened safety glass) bronzed (Parsol bronze)		
Drawers:	Dovetailed solid wood drawers (beech) with covered, smooth-running self-closing drawer runner		
Front profile / Handles:	Aluminium high quality steel effect anodized (EL02)		
Tables:	Framework solid oakwood, table top veneered (oak matured timber brushed) edged in cross-grained wood		
Benches:	Framework solid oakwood, seat and backrest upholstered with cattle hide napa leather or loden		
<b>Loading capacity:</b>	Glass shelf rows 6 mm:	max. 5 kg	Drawers up to 80 cm wide: max. 10 kg
	Glass shelf rows 8 mm:	max. 10 kg	Drawers beyond 80 cm wide: max. 25 kg
	Wooden shelf rows:	max. 20 kg	

## LED-Lighting (optional):

All lighting systems are installed and wired securely in(to) the furniture by VOGLAUER. Every illuminated element has its own controller and/or transformer and a power cable (approx. 2,5m) with EURO-plug. The lamps (illuminant) cannot be replaced in the fixtures.

Optional lighting:

- with internal light switch
- with remote-controlled radio circuit and dimmer (every element comes with its own handheld transmitter - subsequently several lighting systems can be adapted to one single transmitter)

Energy efficiency grade: A - A++

Performance/Consumption: LED-Spot: 2 Watt, LED-Stripe: 4,8 Watt/rm

## Wood Composites - Indoor Climate:

Despite accurate processing wood is a living raw material; standing in reaction with air humidity and adapts to climatical conditions. Different colours, structures, small shakes, slight warping or open knots can be unavoidable consequences. An ideal indoor climate for wooden furniture would be approximately 18-23° C and 44-55 % air humidity. In order to avoid shakes and warpings, solid wood furniture should undergo low variability of the climate.

## Oiled Surfaces:

All Voglauer surfaces equate to organic products concerning their environmental compatibility and ecology. The oiled surface is breathable and improves the indoor climate. The surface is antistatic, i.e. dust- and dirt-repellent.

**Maintenance of oiled surfaces:** To maintain the oiled Voglauer furniture's worth, it is advisable to oil it more or less every 6-8 months. Apply the Voglauer maintenance set (see: additional - „Maintenance oil“) thinly with a smooth, not fraying cloth and spread it evenly in fibre direction. Afterwards polish it with a dry cotton cloth. The surface will shine silk and velvety.

## Upholstery - Loden - Leather:

- 100% Merino wool (highest quality and finest sheep's wool)
- Heavy-weight soft cattle hide napa leather with expressive grain.
- Each skin is unique and has undergone many production steps, hence slight colour differences are inevitable. This must be taken into account especially when comparing original furniture to their samples.
- Wrinkling is a natural procedure and therefore no decrease in quality. It occurs as a consequence of the leather's using or stretching.

## Important Planning Advices:

- Check out constructional conditions, obstructions, measures and resilience at determination of material requirements to ensure a performance free of defects.
- Check out electrical conditions for connections and engineering (freely suspended lighting systems require cable ducts on or under plaster). Every illuminated element has its own power cable (approx. 2,5 m) with EURO-plug. In carcass furniture power connection for lighting (power point, cable exit) can be entirely located behind the rear panel (distance to wall approx. 23 mm).
- The door hinges are nickel-plated and 3-dimensional adjustable. Essential for the door's exact matching is to place the furniture on a flat bottom - in case of unevenness furniture items can be compensated with the included furniture wedges. All elements with doors have to be mounted with distance to the wall, because the doors open over the side of the corpus (knocked open) - according to the sketch.
- All declared values in the price list are theoretical approximate dimensions and due to the aggregate tolerances they deviate from the real dimensions. The total dimensions don't comprehend handles and other irrelevant protruding component parts.

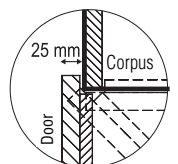







## Installation of the Furniture:

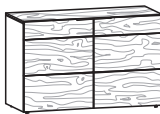
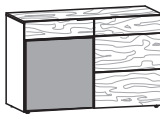
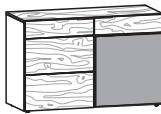
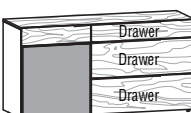
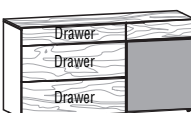
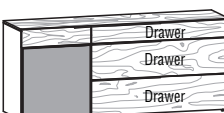
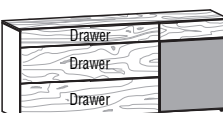
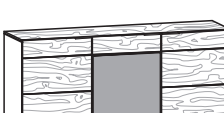
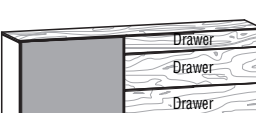
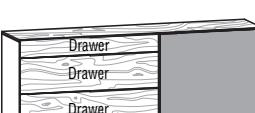



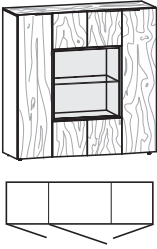
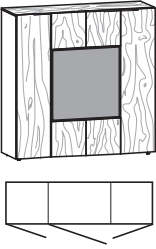

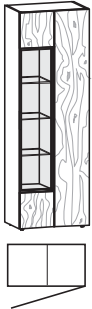

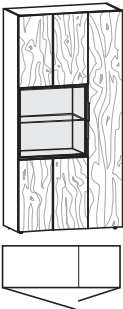
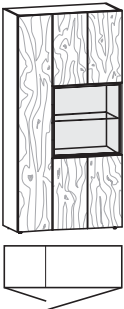
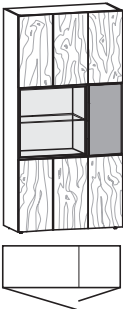
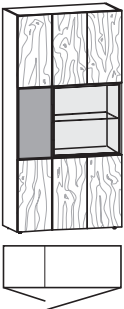
Due to the big doors and full-opening drawers, furniture's standing on the ground has to be attached to the wall, to pretend it from tilting over. VOGLAUER includes the compatible installation-equipment for firm masonry. For drywalls / metal-stud walls the technician has to get compatible dowels and screws by himself. VOGLAUER don't assume any liability for the installation. Every furniture from Voglauer is assembled and performed individually. Some bulky goods are delivered in separate pieces. There are mounting instructions for not assembled goods (e.g. media elements)

## VOGLAUER Furniture Quality Certificate:

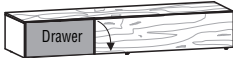

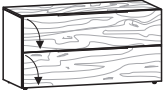
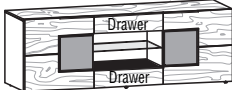
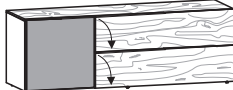

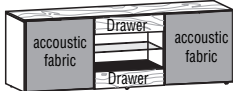
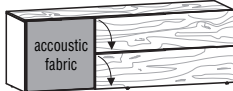





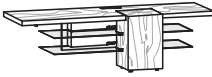
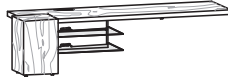
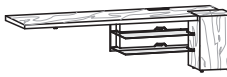

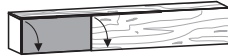
Every consignment comes with a VOGLAUER quality certificate (Online Download: [www.voglauer.com](http://www.voglauer.com)). VOGLAUER do not assume any liability for not conforming to care and maintenance instructions or misuse.







	required distance to wall on opening doors: 3 cm							
	1 loose shelf 		1 loose shelf 		1 loose shelf 			
	W/D/H 128/51,6/82 cm		W/D/H 128/51,6/82 cm		W/D/H 128/51,6/82 cm			
Description	Sideboard 128, 2 doors		Sideboard 128, 2 doors, accent left		Sideboard 128, 2 doors, accent right			
Accent	-		Glass anthracite    Loden (MG/MB/MT)		Glass anthracite    Loden (MG/MB/MT)			
	required distance to wall on opening the doors: 3 cm							
	1 loose shelf 		1 loose shelf 		1 loose shelf 		1 loose shelf 	
	W/D/H 160/51,6/82 cm		W/D/H 160/51,6/82 cm		W/D/H 192/51,6/82 cm		W/D/H 192/51,6/82 cm	
Description	Sideboard 160, 3 drawers, 1 door with accent left		Sideboard 160, 3 drawers, 1 door with accent right		Sideboard 192, 3 drawers, 1 door with accent left		Sideboard 192, 3 drawers, 1 door with accent right	
Accent	Glass anthracite	Loden (MG/MB/MT)	Glass anthracite	Loden (MG/MB/MT)	Glass anthracite	Loden (MG/MB/MT)	Glass anthracite	Loden (MG/MB/MT)
	required distance to wall on opening the doors: 3 cm							
	links 1-trg: 1 loose shelf rechts 2-trg: 1 loose shelf 		1 loose shelf 		1 loose shelf 			
	W/D/H 192/51,6/82 cm		W/D/H 224/51,6/82 cm		W/D/H 224/51,6/82 cm			
Description	Sideboard 192, 3 doors, centered door with accent		Sideboard 224, 3 drawers, 1 sliding door with accent left		Sideboard 224, 3 drawers, 1 sliding door with accent right			
Accent	Glass anthracite	Loden (MG/MB/MT)	Glass anthracite	Loden (MG/MB/MT)	Glass anthracite	Loden (MG/MB/MT)		

	<p>left 3 loose shelves right 2 fixed shelves, 1 glass &amp; 1 loose shelf</p>  <p>W/D/H 96/ 42,3/ 130 cm</p>	<p>left and right 3 loose shelves each center 2 fixed shelves, 1 glass shelf</p>  <p>W/D/H 128/ 42,3/ 130 cm</p>	<p>left, center, right 3 loose shelves each</p>  <p>W/D/H 128/ 42,3/ 130 cm</p>	
Description	Highboard 96, 2 doors with display	Highboard 128, 3 doors with display	Highboard 128, 3 doors with accent	
Accent	-	-	Glass anthracite	Loden (MG/MB/MT)
Extra charge lighting - switch				
Extra charge lighting - remote and dimmer				
	<p>top and bottom: 1 fixed shelf each center: left 3 loose shelves, right 3 glass shelves</p>  <p>W/D/H 64/ 42,3/ 194 cm</p>	<p>top and bottom: 1 fixed shelf each center: left 3 glass shelves, right 3 loose shelves</p>  <p>W/D/H 64/ 42,3/ 194 cm</p>	<p>left 5 loose shelves right 2 fixed shelves, 3 glass and 3 loose shelves</p>  <p>W/D/H 96/ 42,3/ 194 cm</p>	
Description	Disp. cabinet 64, 1 door, door stop left	Disp. cabin. 64, 1 door, door stop right	Disp. cabin. 96, 2 doors, glass centered	
Extra charge lighting - switch				
Extra charge lighting - remote and dimmer				
	<p>left 2 fixed shelves, 1 glass shelf, 2 wooden shelves right 5 loose shelves</p>  <p>W/D/H 96/ 42,3/ 194 cm</p>	<p>left 5 loose shelves right 2 fixed shelves, 1 glass shelf, 2 wooden shelves</p>  <p>W/D/H 96/ 42,3/ 194 cm</p>	<p>left 2 fixed shelves, 1 glass shelf, 2 wooden shelves right 5 loose shelves</p>  <p>W/D/H 96/ 42,3/ 194 cm</p>	<p>left 5 loose shelves right 2 fixed shelves, 1 glass shelf, 2 wooden shelves</p>  <p>W/D/H 96/ 42,3/ 194 cm</p>
Description	Display cabinet 96, 2 doors, glass left	Display cabinet 96, 2 doors, glass right	D.cab. 96 w/ accent, 2 doors, glass left	D.cab. 96 w/ accent, 2 doors, glass right
	-	-	Glass anthracite	Loden (MG/MB/MT)
Extra charge lighting - switch				
Extra charge lighting - remote and dimmer				

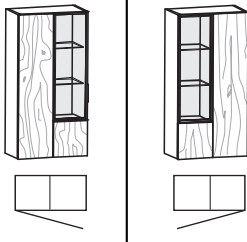







For cable duct no rear panel at the bottom (14,6 cm open)							
							
	W/D/H 128/55/34 cm	W/D/H 192/55/34 cm	W/D/H 192/55/34 cm	W/D/H 192/55/34 cm			
Description	Lowboard 128/34, 1 hatch	Lowboard 192/34, 1 hatch	Lowboard 192/34, 1 hatch, 1 drawer, accent drawer left		Lowboard 192/34, 1 hatch, 1 drawer, accent drawer right		
Accent	-	-	Glass anthracite	Loden (MG/MB/MT)	Glass anthracite	Loden (MG/MB/MT)	
Ex.ch. drawer 128 instead of hatch							
Ex.ch. double drawer 192 instead of hatch							
Extra charge Cable management - Hatch incl. plug connector							
required distance to wall on opening doors: 3 cm - for cable duct distance between rear panel and wall: 8,4 cm							
							
	W/D/H 128/55/66 cm	W/D/H 192/55/66 cm	W/D/H 192/55/66 cm	W/D/H 192/55/66 cm			
Description	Lowboard 128/66, 2 hatches	Lowboard 192/66, 2 doors with accent, center: 2 drawers & open	Lowboard 192/66, 2 hatches, 1 door with accent left		Lowboard 192/66, 2 hatches, 1 door with accent right		
Accent	-	Glass anthracite   Loden (MG/MB/MT)	Glass anthracite	Loden (MG/MB/MT)	Glass anthracite	Loden (MG/MB/MT)	
Ex.ch. drawer 128 instead of hatch							
Extra charge Cable management - Hatch incl. plug connector							
for cable duct distance between rear panel and wall: 8,4 cm							
							
	W/D/H 192/55/66 cm	W/D/H 192/55/66 cm	W/D/H 192/55/66 cm				
Description	Lowboard 192/66, 2 acoustic doors, center: 2 drawers & open		Lowboard 192/66, 2 hatches, acoustic door left		Lowboard 192/66, 2 hatches, acoustic door right		
Extra charge drawer 128 instead of hatch							
Extra charge Cable management - Hatch incl. plug connector							





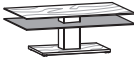
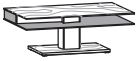

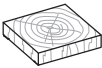

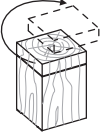
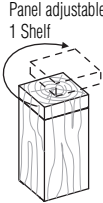
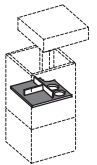
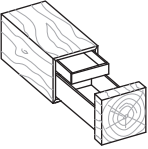
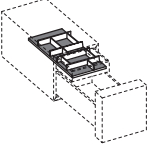

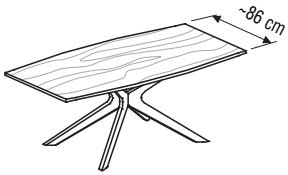
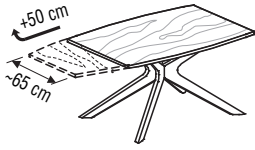
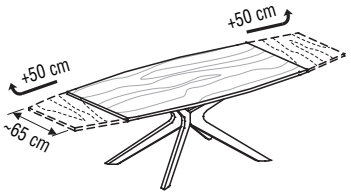
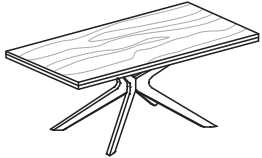
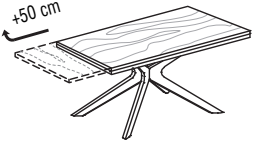
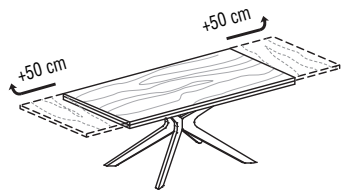
	with cable ducts, cable storage space in removable rear panel			
				
	W/D/H 176/56,7/50 cm	W/D/H 176/56,7/50 cm	W/D/H 192/56,7/50 cm	W/D/H 192/56,7/50 cm
Description	Media element 176, left	Media element 176, right	Media element 192, left	Media element 192, right
Total resilience max. 70 kg				
			1 carcass side, (shelf width left 61, right 125 cm)	
	W/D/H 128/37,3/32 cm	W/D/H 192/37,3/32 cm		
	W/D/H 128/37,3/32 cm	W/D/H 192/37,3/32 cm	W/D/H 192/37,3/32 cm	W/D/H 192/37,3/32 cm
Description	Suspended element 128, 1 hatch downwards	Suspended element 192, 1 hatch downwards	Suspended element 192, 2 hatches downwards, accent left	Suspended element 192, 2 hatches downwards, accent right
Accent	-	-	Glass anthracite   Loden (MG/MB/MT)	Glass anthracite   Loden (MG/MB/MT)
Extra charge lighting - switch				
Ext. charge lighting - remote&dimmer				
Total resilience max. 70 kg				
			1 carcass side, (shelf width left 61, right 125 cm)	
	W/D/H 128/37,3/32 cm	W/D/H 192/37,3/32 cm		
	W/D/H 128/37,3/32 cm	W/D/H 192/37,3/32 cm	W/D/H 192/37,3/32 cm	W/D/H 192/37,3/32 cm
Description	Suspended element 128, 1 hatch upwards	Suspended element 192, 1 hatch upwards	Suspended element 192, 2 hatches upwards, accent left	Suspended element 192, 2 hatches upwards, accent right
Accent	-	-	Glass anthracite   Loden (MG/MB/MT)	Glass anthracite   Loden (MG/MB/MT)
Extra charge lighting - switch				
Ext. charge lighting - remote&dimmer				
	Total resilience max. 10 kg Glass shelf Parsol glass 8 mm - Stell depth 19 cm		Total resilience max. 10 kg, with fitting	
				
	W/D/H 128/23/18,2 cm	W/D/H 192/23/18,2 cm	W/D/H 128/24/3,9 cm	W/D/H 192/24/3,9 cm
Description	Wall panel with glass shelf 128 cm	Wall panel with glass shelf 192 cm	Inserted wall board 128 cm	Inserted wall board 192 cm
Extra charge lighting - switch				
Ext. charge lighting - remote&dimmer				

	<p>Total resilience max. 70 kg bottom: 1 fixed shelf top: 2 glass &amp; 2 loose wooden shelves each</p>  <p>W/D/H 64/37,3/128 cm</p>		<p>Total resilience max. 40 kg</p> <p>1 glass shelf</p>  <p>W/D/H 64/37,3/64 cm</p>		<p>required distance to wall on opening doors: 3 cm</p> <p>1 loose shelf</p>  <p>W/D/H 64/37,3/64 cm</p>			
Description	Suspended element 64/128, 1 door Door stop left   Door stop right		Suspended element 64/64, 1 door Door stop left   Door stop right		Suspended element 64/64, 1 door, with accent, door stop left		Suspended element 64/64, 1 door, with accent, door stop right	
Accent	-		-		Glass anthracite	Loden (MG/MB/MT)	Glass anthracite	Loden (MG/MB/MT)
Extra charge lighting - switch								
Ext. charge lighting - remote&dimmer								
	<p>Total resilience max. 50 kg required distance to wall on opening doors: 3 cm</p> <p>2 fixed shelves 1 glass shelf</p>  <p>W/D/H 32/37,3/128 cm</p>				<p>2 fixed shelves 2 glass shelves</p>  <p>W/D/H 32/37,3/160 cm</p>			
Description	Susp. display cabinet 32/128, 1 door, with accent, door stop left		Susp. display cabinet 32/128, 1 door, with accent, door stop right		Susp. display cabinet 32/160, 1 door, with accent, door stop left		Susp. display cabinet 32/160, 1 door, with accent, door stop right	
Accent	Glass anthracite	Loden (MG/MB/MT)	Glass anthracite	Loden (MG/MB/MT)	Glass anthracite	Loden (MG/MB/MT)	Glass anthracite	Loden (MG/MB/MT)
Extra charge lighting - switch								
Extra charge lighting - remote and dimmer								
	<p>Total resilience max. 50 kg required distance to wall on opening doors: 3 cm</p> <p>3 loose shelves</p>  <p>W/D/H 32/37,3/128 cm</p>				<p>4 loose shelves</p>  <p>W/D/H 32/37,3/160 cm</p>			
Description	Suspended element 32/128, 1 door, wooden accent, door stop left		Suspended element 32/128, 1 door, wooden accent, door stop right		Suspended element 32/160, 1 door, wooden accent, door stop left		Suspended element 32/160, 1 door, wooden accent, door stop right	
Accent	Glass anthracite	Loden (MG/MB/MT)	Glass anthracite	Loden (MG/MB/MT)	Glass anthracite	Loden (MG/MB/MT)	Glass anthracite	Loden (MG/MB/MT)







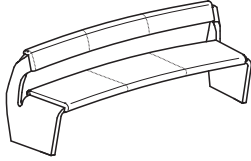

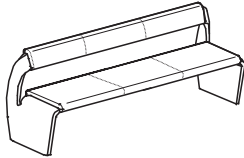
<b>Coffee Tables 90/90 cm</b> bottom panel and drawer front color glass anthracite						
	 B/T/H 90/90/46 cm	 B/T/H 90/90/46 cm	 B/T/H 90/90/46 cm	height adjustable 38,3 to 74,3 cm  B/T/H 90/90/38,3 cm		
Description	Coffee table 90/90 cm, without drawers	Coffee table 90/90 cm, with 1 drawer	Coffee table 90/90 cm, with 2 drawers	Coffee table 90/90 cm, height adj., 2 drawers		
<b>Coffee Tables 75/120 cm</b> bottom panel and drawer front color glass anthracite						
	 B/T/H 75/120/46 cm	 B/T/H 75/120/46 cm	 B/T/H 75/120/46 cm			
Description	Coffee table 75/120cm, without drawers	Coffee table 75/120cm, with 1 drawer	Coffee table 75/120cm, with 2 drawers			
<b>Panel with end-grain-inlay</b>						
	 W/D/H 48/48/10 cm	 W/D/H 34,4/34,4/34,9 cm	Panel adjustable  W/D/H 34,4/34,4/52 cm	Panel adjustable 1 Shelf  W/D/H 34,4/34,4/73 cm	 Available for articles <b>DK52, DK73</b> W/D/H 30/30/5,5 cm	
Description	Cube 48/48, 10 cm height	Cube 34/34, 35 cm height	Cube 34/34, 35 cm height	Cube 34/34, 35 cm height	variable accessories	
<b>Drawer-front-end with end-grain-inlay</b>						
	 W/D/H 34,4/80/34,9 cm	 Available for top drawer by <b>DK80</b> W/D/H 25,9/59,3/5,5 cm				
Description	Cube 80/34, 35 cm height, 2 drawers	variable accessories				

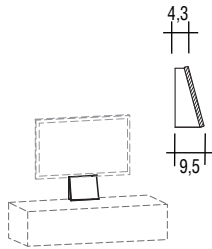
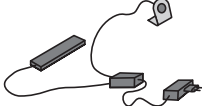



	 <p>table height 76,5 cm</p>				 <p><b>only possible for table length 140</b></p>		 <p><b>only possible for table lengths 160, 180, 200</b></p>	
Description	Dining room table rounded				extra charge. 1 elongation 1x50 cm		extra ch. 2 table elongations 2x50 cm	
Measures W/L	96,5/140 cm	99/160 cm	100/180 cm	100/200 cm	+ 50 cm		+ 2 x 50 cm	
	 <p>table height 76,5 cm</p>				 <p><b>only possible for table length 140</b></p>		 <p><b>only possible for table lengths 160, 180, 200</b></p>	
Description	Dining room table squared				extra charge. 1 elongation 1x 50cm		extra ch. 2 table elongations 2x 50cm	
Measures W/L	90/140 cm	100/160 cm	100/180 cm	100/200 cm	+ 50 cm		+ 2 x 50 cm	
Seat height approx. 48 cm Synthetic glides on all chairs (felt glides included)	Seat and backrest upholstered with loden or leather accord. to coll. Chair stackable				Seat and backrest upholstered Back upholsterd (other fabric available)			
	 <p>W/D/H ca. 53/ 57/ 82 cm</p>		 <p>W/D/H ca. 62/ 63/ 83 cm</p>		 <p>W/D/H 50/61/88 cm</p>		Meintion details: <input type="checkbox"/> Fabric back <input type="checkbox"/> Fabric seat	
Description	Upholstered chair 35				Upholsterd cahir 64			
Upholstery	Loden	Leather	Loden	Leather	Loden	Leather	Leather-Loden combination	
Seat height approx. 48 cm Synthetic glides on all chairs (felt glides included)	Seat upholstert, backrest wood Chair stackable		Seat and backrest upholstered with loden or leather accord. to coll. suitably edged with leather piping (black leather piping with loden)			Seat and backrest upholstered with leather accord. to coll.		
	 <p>W/D/H ca. 54/ 61/ 86 cm</p>		 <p>W/D/H ca. 49/ 54/ 89 cm</p>		 <p>W/D/H ca. 59/ 54/ 89 cm</p>		 <p>W/D/H ca. 49/ 56/ 85 cm</p>	
Description	Chair 55		Upholstered chair 46		Upholstered chair 46, with armrests		Upholstered chair 4	
Upholstery	Loden	Leather	Loden	Leather	Loden	Leather	Loden	Leather
							undeliverable	

	<p><u>Upholstery seat:</u> Foamed material 35 mm Density 50 Hardness 75</p> <p>Seat and backrest upholstered with cattle hide napa leather accord. to coll. seat height approx. 49 cm</p> 							
Description	Seating bench rounded 167 cm (suitable for table 140)		Seating bench rounded 187 cm (suitable for table 160)		Seating bench rounded 207 cm (suitable for table 180)		Seating bench rounded 227 cm (suitable for table 200)	
Measures W/D/H	166,5/69,6/84 cm		186,5/69,6/84 cm		206,5/69,6/84 cm		226,5/69,6/84 cm	
Upholstery	Loden	Leather	Loden	Leather	Loden	Leather	Loden	Leather

	<p><u>Upholstery seat:</u> Foamed material 35 mm Density 50 Hardness 75</p> <p>Seat and backrest upholstered with cattle hide nappa leather accord. to coll. seat height approx. 49cm</p> 							
Description	Seating bench straight 155 cm (suitable for table 140)		Seating bench straight 175 cm (suitable for table 160)		Seating bench straight 195 cm (suitable for table 180)		Seating bench straight 215 cm (suitable for table 200)	
Measures W/D/H	155/70/84 cm		175/70/84 cm		195/70/84 cm		215/70/84 cm	
Upholstery	Loden	Leather	Loden	Leather	Loden	Leather	Loden	Leather

	<p>removable front panel (Magnetic catchers)</p>  <p>W/D/H 25/9,5/20 cm</p>	<p>Conducts signals of customary remote control through closed furniture front.</p> <p>The TV equipment shouldn't be separated by carcass sides - they have to be well-positioned in one corpus.</p> 	<p>CLV board veneered, edged around</p> <p>max. Length 252 cm max. Width 110 cm</p> <p>Thickness of material: 14,20 oder 23 mm</p>  <p>price per m2 (calculated min. 0,5 m2)</p>	
Description	Cable duct	Infrarot-Repeater	Cover plate double sided veneered	

<b>WOOD MAINTENANCE</b>				
	<p>250 ml Voglauer Maintenance oil and polishing cloth</p>  <p>The original Voglauer wood maintenance oil cleans and refreshes the surfaces and at the same time creates a breathable protective film.</p>	<p>Repair set comprises:</p> <p>100 ml Voglauer cleanser 100 ml Surface oil Scotch-Bride and polishing cloths</p>  <p>In order to fix little surface damages and impureness.</p>	<ul style="list-style-type: none"> <li>- Motion sensor</li> <li>- 6x LED, 0,5 Watt</li> <li>- with charging cable</li> <li>- in case of USB rechargeable</li> <li>- individ. fixing under shelf</li> <li>- no cabling essential</li> </ul>  <p>W/D/H ca. 10/8,5/1 cm</p>	<p>Mains plug with USB-connect for loading of the Battery-LED-light (Standard USB-Recharger 5V/DC, 1 Ampere, 100-240 V)</p>  <p>W/D/H ca. 4/6,5/1,7 cm</p>
Description	Maintenance set for oiled surfaces	Repair set for oiled surfaces	Battery-LED-light	USB-Recharger

<b>LEATHER MAINTENANCE</b>				
	<p>200 ml soft cleaner 200 ml maintenance cream with light protection Sponge and cloths</p>  <p>The original Voglauer leather maintenance set for thorough and yet gentle cleaning as well as impregnation of leather. <b>Recommended:</b> 2 - 4 applications per year.</p>	<p>Contents 200 ml</p>  <p>To remove strong, not fatty pollution and dust deposit on the leather.</p>	<p>Contents 200 ml</p>  <p>Highly effective impregnation and light protection. The dubbin gets refreshed and the leather stays soft and sleek, retarding the fading of the color.</p>	<p>Contents 200 ml</p>  <p>To refresh faded and galled leather.</p> <p><b>Recommended:</b> Impregnation with maintenance cream afterwards</p> <p>Indicate <b>Color of leather!</b></p>
Description	Leather maintenance set	Leather intensive cleaner	Leather maintenance cream	Leather color lotion

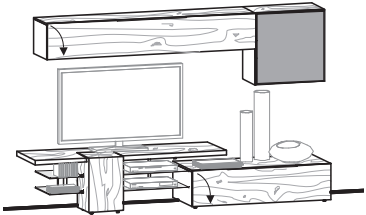

<p><b>SUGGESTION 154</b> W/D/H 272 / 56,7 / 168 cm</p>  <p>(Suggestions always without extra charge articles)</p>	Accent	Glass anthracite	Loden (MG/MB/MT)
	Extra charge lighting - Switch		
	Extra charge lighting - Remote & Dimmer		
	Extra charge drawer 128 instead of hatch for Lowboard		
	Extra charge Cable management for Lowboard		
	Suggestion (ill.)comprises:	1x Lowboard 128/34, 1 hatch 1x Media element 176, left 1x Suspended element 192, 1 hatch downwards 1x Suspended element 64/64, 1 door with accent, door stop right	

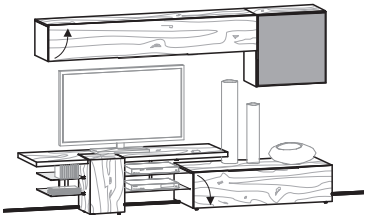
<p><b>SUGGESTION 155</b> W/D/H 272 / 56,7 / 168 cm</p>  <p>(Suggestions always without extra charge articles)</p>	Accent	Glass anthracite	Loden (MG/MB/MT)
	Extra charge lighting - Switch		
	Extra charge lighting - Remote & Dimmer		
	Extra charge drawer 128 instead of hatch for Lowboard		
	Extra charge Cable management for Lowboard		
	Suggestion (ill.)comprises:	1x Lowboard 128/34, 1 hatch 1x Media element 176, left 1x Suspended element 192, 1 hatch upwards 1x Suspended element 64/64, 1 door with accent, door stop right	

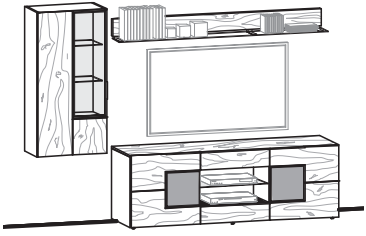
<p><b>SUGGESTION 168</b> W/D/H 272 / 55 / 194 cm</p>  <p>(Suggestions always without extra charge articles)</p>	Accent	Glass anthracite	Loden (MG/MB/MT)	
	Extra charge lighting - Switch			
	Extra charge lighting - Remote & Dimmer			
	Extra charge Cable management for Lowboard			
	Suggestion (ill.)comprises:	1x Lowboard 192/66, 2 doors with accent, center 2 drawers & open 1x Suspended display cabinet 64/128, 1 door, door stop left 1x Wall panel with glass shelf 192 cm		

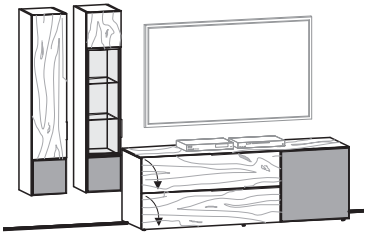
<p><b>SUGGESTION 182</b> W/D/H 287 / 55 / 194 cm</p>  <p>(Suggestions always without extra charge articles)</p>	Accent	Glass anthracite	Loden (MG/MB/MT)
	Extra charge lighting - Switch		
	Extra charge lighting - Remote & Dimmer		
	Extra charge drawer 128 instead of hatch for Lowboard*		
	Extra charge Cable management for Lowboard		
	Suggestion (ill.)comprises:	1x Lowboard 192/66, 2 hatches, 1 door with accent right 1x Suspended element 32/160, 1 door, wooden accent, door stop left 1x Suspended display cabinet 32/128, 1 door with accent, door stop left	

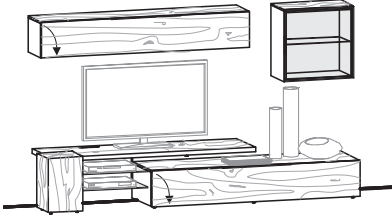
<p><b>SUGGESTION 196</b> W/D/H 288 / 56,7 / 168 cm</p>  <p>(Suggestions always without extra charge articles)</p>			
	Extra charge lighting - Switch		
	Extra charge lighting - Remote & Dimmer		
	Extra ch. double drawer 192 instead of hatch for Lowboard		
	Extra charge Cable management for Lowboard		
	<p>Suggestion (ill.)comprises: 1x Lowboard 192/34, 1 hatch                  1x Media element 192, left                  1x Suspended element 192, 1 hatch downwards                  1x Suspended display cabinet 64/64, 1 door, door stop right</p>		

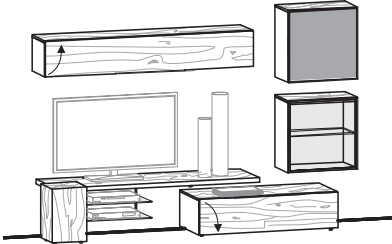
<p><b>SUGGESTION 210</b> W/D/H 288 / 56,7 / 194 cm</p>  <p>(Suggestions always without extra charge articles)</p>	Accent	Glass anthracite	Loden (MG/MB/MT)
	Extra charge lighting - Switch		
	Extra charge lighting - Remote & Dimmer		
	Extra charge drawer 128 instead of hatch for Lowboard		
	Extra charge Cable management for Lowboard		
	<p>Suggestion (ill.)comprises: 1x Lowboard 128/34, 1 hatch                  1x Media element 192, left                  1x Suspended element 192, 1 hatch upwards                  1x Suspended display cabinet 64/64, 1 door, door stop right                  1x Suspended element 64/64, 1 door with accent, door stop right</p>		

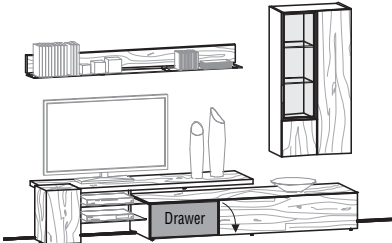
<p><b>SUGGESTION 224</b> W/D/H 288 / 56,7 / 194 cm</p>  <p>(Suggestions always without extra charge articles)</p>	Accent	Glass anthracite	Loden (MG/MB/MT)
	Extra charge lighting - Switch		
	Extra charge lighting - Remote & Dimmer		
	Extra charge drawer 128 instead of hatch for Lowboard		
	Extra charge Cable management for Lowboard		
	<p>Suggestion (ill.)comprises: 1x Lowboard 192/34, 1 hatch, 1 drawer, accent drawer left                  1x Media element 192, left                  1x Suspended display cabinet 64/128, 1 door, door stop right                  1x Wall panel with glass shelf 192 cm</p>		

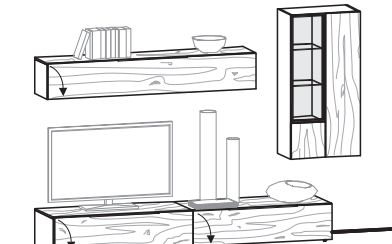
<p><b>SUGGESTION 238</b> W/D/H 288 / 55 / 200 cm</p>  <p>(Suggestions always without extra charge articles)</p>			
	Extra charge lighting - Switch		
	Extra charge lighting - Remote & Dimmer		
	Extra charge drawer 128 instead of hatch for Lowboard*		
	Extra charge Cable management for Lowboard		
	<p>Suggestion (ill.)comprises: 2x Lowboard 128/34, 1 hatch                  1x Suspended element 192, 1 hatch downwards                  1x Suspended display cabinet 64/128, 1 door, door stop right</p>		

\* Please indicate where accessories are to be installed

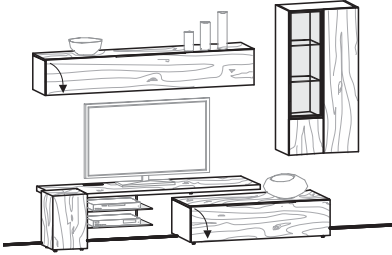

<p><b>SUGGESTION 252</b>      W/D/H 288 / 55 / 200 cm</p>  <p>(Suggestions always without extra charge articles)</p>			
	Extra charge lighting - Switch		
	Extra charge lighting - Remote & Dimmer		
	Extra charge drawer 128 instead of hatch for Lowboard		
	Extra charge Cable management for Lowboard		
	<p>Suggestion (ill.)comprises:    1x                      Lowboard 128/34, 1 hatch             1x                      Media element 192, left             1x                      Suspended element 192, 1 hatch downwards             1x                      Suspended display cabinet 64/128, 1 door, door stop right</p>		

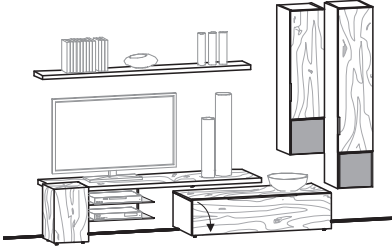
<p><b>SUGGESTION 266</b>      W/D/H 300 / 56,7 / 194 cm</p>  <p>(Suggestions always without extra charge articles)</p>	Accent	Glass anthracite	Loden (MG/MB/MT)	
		Extra charge drawer 128 instead of hatch for Lowboard		
		Extra charge Cable management for Lowboard		
	<p>Suggestion (ill.)comprises:    1x                      Lowboard 128/34, 1 hatch             1x                      Media element 192, left             1x                      Inserted wall board 192 cm             1x                      Suspended element 32/128, 1 door, wooden accent, door stop right             1x                      Suspended element 32/160, 1 door, wooden accent, door stop right</p>			

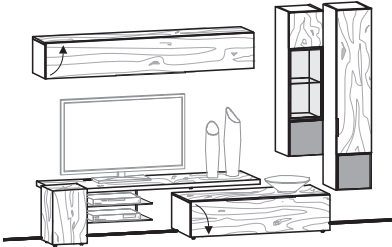
<p><b>SUGGESTION 280</b>      W/D/H 300 / 56,7 / 194 cm</p>  <p>(Suggestions always without extra charge articles)</p>	Accent	Glass anthracite	Loden (MG/MB/MT)	
		Extra charge lighting - Switch		
		Extra charge lighting - Remote & Dimmer		
	Extra charge drawer 128 instead of hatch for Lowboard			
	Extra charge Cable management for Lowboard			
	<p>Suggestion (ill.)comprises:    1x                      Lowboard 128/34, 1 hatch             1x                      Media element 192, left             1x                      Suspended element 192, 1 hatch upwards             1x                      Suspended display cabinet 32/128, 1door with accent, door stop right             1x                      Suspended element 32/160, 1 door, wooden accent, door stop right</p>			

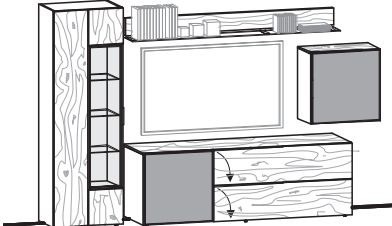
<p><b>SUGGESTION 294</b>      W/D/H 303 / 55 / 194 cm</p>  <p>(Suggestions always without extra charge articles)</p>	Accent	Glass anthracite	Loden (MG/MB/MT)	
		Extra charge lighting - Switch		
		Extra charge lighting - Remote & Dimmer		
	Extra charge drawer 128 instead of hatch for Lowboard*			
	Extra charge Cable management for Lowboard			
	<p>Suggestion (ill.)comprises:    1x AV64G-L      Display cabinet 64, 1 door, door stop left             1x ALH19A-L    Lowboard 192/66, 2 hatches, 1 door with accent left             1x AHE66A-R    Suspended element 64/64, 1 door with accent, door stop right             1x AWB19        Wall panel with glass shelf 192 cm</p>			

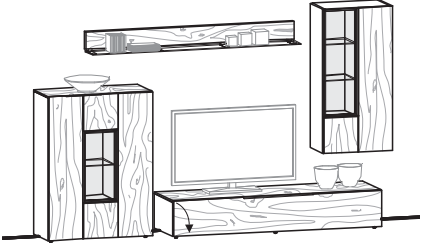
<p><b>SUGGESTION 308</b> W/D/H 319 / 55 / 194 cm</p>  <p>(Suggestions always without extra charge articles)</p>			
	Extra charge lighting - Switch		
	Extra charge lighting - Remote & Dimmer		
	Extra ch. double drawer 192 instead of hatch for Lowboard		
	Extra charge Cable management for Lowboard		
	<p>Suggestion (ill.)comprises: 1x Highboard 96, 2 doors with glass                  1x Lowboard 192/34, 1 hatch                  1x Wall panel with glass shelf 192 cm                  1x Suspended display cabinet 64/128, 1 door, door stop right</p>		

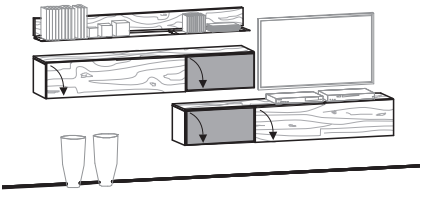
<p><b>SUGGESTION 322</b> W/D/H 320 / 37,3 / 148 cm</p>  <p>(Suggestions always without extra charge articles)</p>	Accent	Glass anthracite	Loden (MG/MB/MT)
	Extra charge lighting - Switch		
	Extra charge lighting - Remote & Dimmer		
	Extra charge Cable duct for lower Suspended element		
	<p>Suggestion (ill.)comprises: 1x Suspended element 192, 2 hatches downwards, accent left                  1x Suspended element 192, 2 hatches downwards, accent right                  1x Wall panel with glass shelf 192 cm</p>		

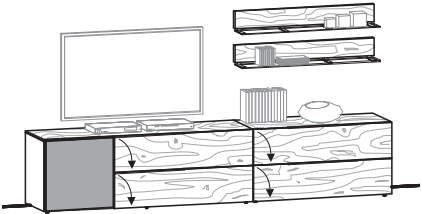
<p><b>SUGGESTION 336</b> W/D/H 320 / 55 / 163 cm</p>  <p>(Suggestions always without extra charge articles)</p>	Accent	Glass anthracite	Loden (MG/MB/MT)
	Extra charge lighting - Switch		
	Extra charge lighting - Remote & Dimmer		
	Extra charge drawer 128 instead of hatch for Lowboard *		
	Extra charge Cable management for Lowboard 192		
	<p>Suggestion (ill.)comprises: 1x Lowboard 192/66, 2 hatches, 1 door with accent left                  1x Lowboard 128/66, 2 hatches                  2x Wall panel with glass shelf 128 cm</p>		

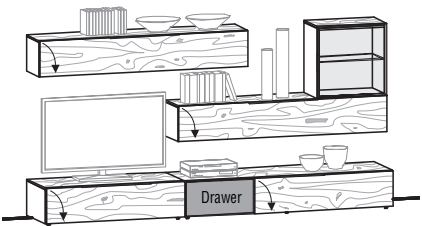
<p><b>SUGGESTION 350</b> W/D/H 320 / 55 / 162 cm</p>  <p>(Suggestions always without extra charge articles)</p>	Accent	Glass anthracite	Loden (MG/MB/MT)
	Extra charge lighting - Switch		
	Extra charge lighting - Remote & Dimmer		
	Extra charge drawer 128 instead of hatch for Lowboard *		
	Extra charge Cable management for Lowboard 128		
	<p>Suggestion (ill.)comprises: 1x Lowboard 128/34, 1 hatch                  1x Lowboard 192/34, 1 hatch, 1 drawer, accent drawer left                  2x Suspended element 192, 1 hatch downwards                  1x Suspended display cabinet 64/64, 1 door, door stop right</p>		

\* Please indicate where accessories are to be installed

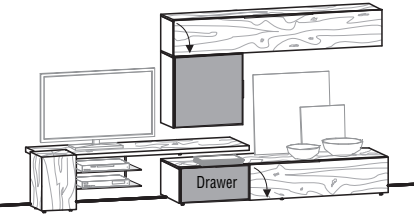
<p><b>SUGGESTION 364</b> W/D/H 320 / 56,7 / 162 cm</p>  <p>(Suggestions always without extra charge articles)</p>	Accent	Glass anthracite	Loden (MG/MB/MT)
	Extra charge lighting - Switch		
	Extra charge lighting - Remote & Dimmer		
	Extra charge drawer 128 instead of hatch for Lowboard		
	Extra charge Cable management for Lowboard		
	Suggestion (ill.)comprises:	1x Lowboard 192/34, 1 hatch, 1 drawer, accent drawer left 1x Media element 192, left 1x Suspended element 64/64, 1 door with accent, door stop left 1x Suspended element 192, 1 hatch downwards	

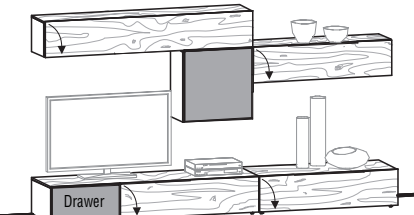
<p><b>SUGGESTION 378</b> W/D/H 320 / 55 / 168 cm</p>  <p>(Suggestions always without extra charge articles)</p>	Accent	Glass anthracite	Loden (MG/MB/MT)
	Extra charge lighting - Switch		
	Extra charge lighting - Remote & Dimmer		
	Extra charge drawer 128 instead of hatch for Lowboard *		
	Extra charge Cable management for Lowboard 192		
	Suggestion (ill.)comprises:	1x Lowboard 192/34, 1 hatch, 1 drawer, accent drawer left 1x Lowboard 128/34, 1 hatch 1x Suspended element 64/64, 1 door with accent, door stop left 1x Suspended element 128, 1 hatch downwards 1x Suspended element 192, 1 hatch upwards	

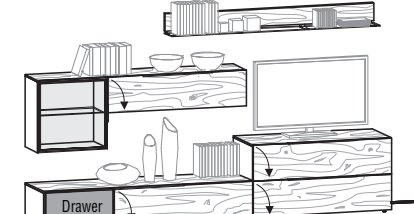
<p><b>SUGGESTION 392</b> W/D/H 320 / 55 / 178 cm</p>  <p>(Suggestions always without extra charge articles)</p>	Accent	Glass anthracite	Loden (MG/MB/MT)
	Extra charge lighting - Switch		
	Extra charge lighting - Remote & Dimmer		
	Extra charge drawer 128 instead of hatch for Lowboard *		
	Extra charge Cable management for Lowboard 128		
	Suggestion (ill.)comprises:	1x Lowboard 192/34, 1 hatch, 1 drawer, accent drawer left 1x Lowboard 128/66, 2 hatches 1x Suspended display cabinet 64/64, 1 door, door stop left 1x Suspended element 128, 1 hatch downwards 1x Wall panel with glass shelf 192 cm	

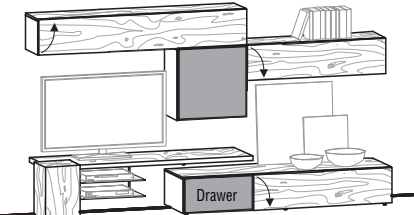
<p><b>SUGGESTION 406</b> W/D/H 320 / 56,7 / 178 cm</p>  <p>(Suggestions always without extra charge articles)</p>	Accent	Glass anthracite	Loden (MG/MB/MT)
	Extra charge lighting - Switch		
	Extra charge lighting - Remote & Dimmer		
	Extra charge drawer 128 instead of hatch for Lowboard		
	Extra charge Cable management for Lowboard		
	Suggestion (ill.)comprises:	1x Lowboard 192/34, 1 hatch, 1 drawer, accent drawer left 1x Media element 192, left 1x Suspended element 64/64, 1 door with accent, door stop left 1x Suspended element 128, 1 hatch downwards 1x Suspended element 192, 1 hatch upwards	

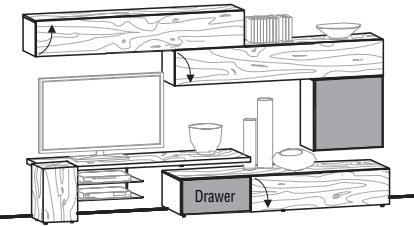
<p><b>SUGGESTION 420</b> W/D/H 320 / 56,7 / 178 cm</p>  <p>(Suggestions always without extra charge articles)</p>	Accent	Glass anthracite	Loden (MG/MB/MT)	
	Extra charge lighting - Switch			
	Extra charge lighting - Remote & Dimmer			
	Extra charge drawer 128 instead of hatch for Lowboard			
	Extra charge Cable management for Lowboard			
	Suggestion (ill.)comprises:	1x Lowboard 192/34, 1 hatch, 1 drawer, accent drawer left 1x Media element 192, left 1x Suspended element 64/64, 1 door with accent, door stop right 1x Suspended element 192, 1 hatch downwards 1x Suspended element 192, 1 hatch upwards		

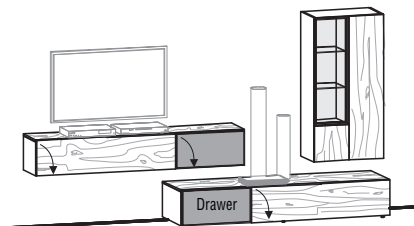
<p><b>SUGGESTION 434</b> W/D/H 320 / 55 / 178 cm</p>  <p>(Suggestions always without extra charge articles)</p>	Accent	Glass anthracite	Loden (MG/MB/MT)
	Extra charge lighting - Switch		
	Extra charge lighting - Remote & Dimmer		
	Extra charge drawer 128 instead of hatch for Lowboard		
	Extra charge Cable management for Lowboard		
	Extra charge Cable duct for Suspended element		
	Suggestion (ill.)comprises:	1x Lowboard 192/34, 1 hatch, 1 drawer, accent drawer left 1x Suspended element 192, 2 hatches downwards, accent right 1x Suspended display cabinet 64/128, 1 door, door stop right	

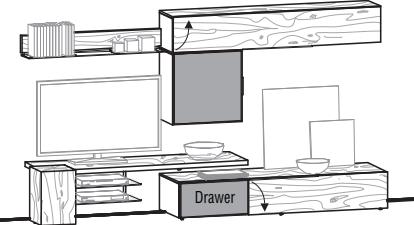
<p><b>SUGGESTION 448</b> W/D/H 320 / 56,7 / 178 cm</p>  <p>(Suggestions always without extra charge articles)</p>	Accent	Glass anthracite	Loden (MG/MB/MT)	
	Extra charge lighting - Switch			
	Extra charge lighting - Remote & Dimmer			
	Extra charge drawer 128 instead of hatch for Lowboard			
	Extra charge Cable management for Lowboard			
	Suggestion (ill.)comprises:	1x Lowboard 192/34, 1 hatch, 1 drawer, accent drawer left 1x Media element 192, left 1x Suspended element 64/64, 1 door with accent, door stop left 1x Suspended element 192, 1 hatch upwards 1x Wall panel with glass shelf 128 cm		

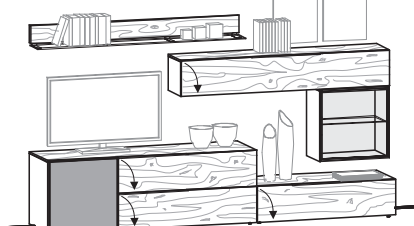
<p><b>SUGGESTION 462</b> W/D/H 320 / 55 / 178 cm</p>  <p>(Suggestions always without extra charge articles)</p>	Accent	Glass anthracite	Loden (MG/MB/MT)	
	Extra charge lighting - Switch			
	Extra charge lighting - Remote & Dimmer			
	Extra charge drawer 128 instead of hatch for Lowboard *			
	Extra charge Cable management for Lowboard 192			
	Suggestion (ill.)comprises:	1x Lowboard 192/66, 2 hatches, 1 door with accent left 1x Lowboard 128/34, 1 hatch 1x Suspended element 64/64, 1 door, door stop right 1x Suspended element 192, 1 hatch downwards 1x Wall panel with glass shelf 192 cm		

\* Please indicate where accessories are to be installed

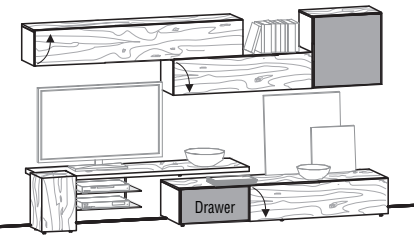
<p><b>SUGGESTION 476</b> W/D/H 320 / 56,7 / 178 cm</p>  <p>(Suggestions always without extra charge articles)</p>	Accent	Glass anthracite	Loden (MG/MB/MT)
	Extra charge lighting - Switch		
	Extra charge lighting - Remote & Dimmer		
	Extra charge drawer 128 instead of hatch for Lowboard		
	Extra charge Cable management for Lowboard		
<p>Suggestion (ill.)comprises: 1x AL19A-L Lowboard 192/34, 1 hatch, 1 drawer, accent drawer left                  1x AM19-L Media element 192, left                  1x AHU12 Suspended element 128, 1 hatch downwards                  1x AHE66A-R Suspended element 64/64, 1 door with accent, door stop right                  1x AH019 Suspended element 192, 1 hatch upwards</p>			

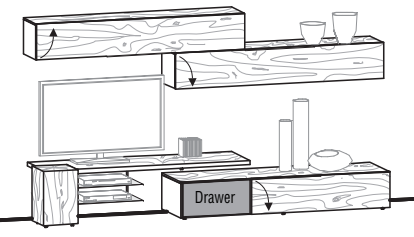
<p><b>SUGGESTION 490</b> W/D/H 320 / 56,7 / 178 cm</p>  <p>(Suggestions always without extra charge articles)</p>	Accent	Glass anthracite	Loden (MG/MB/MT)
	Extra charge lighting - Switch		
	Extra charge lighting - Remote & Dimmer		
	Extra charge drawer 128 instead of hatch for Lowboard		
	Extra charge Cable management for Lowboard		
<p>Suggestion (ill.)comprises: 1x Lowboard 192/34, 1 hatch, 1 drawer, accent drawer left                  1x Media element 192, left                  1x Suspended element 192, 1 hatch downwards                  1x Suspended element 192, 1 hatch upwards</p>			

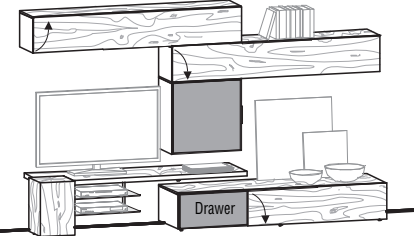
<p><b>SUGGESTION 504</b> W/D/H 320 / 56,7 / 194 cm</p>  <p>(Suggestions always without extra charge articles)</p>	Accent	Glass anthracite	Loden (MG/MB/MT)
	Extra charge lighting - Switch		
	Extra charge lighting - Remote & Dimmer		
	Extra charge drawer 128 instead of hatch for Lowboard		
	Extra charge Cable management for Lowboard		
<p>Suggestion (ill.)comprises: 1x Lowboard 192/34, 1 hatch, 1 drawer, accent drawer left                  1x Media element 192, left                  1x Suspended element 64/64, 1 door with accent, door stop left                  1x Suspended element 192, 1 hatch downwards                  1x Suspended element 192, 1 hatch upwards</p>			

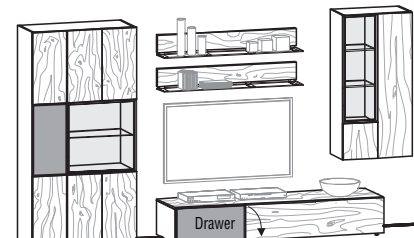
<p><b>SUGGESTION 518</b> W/D/H 352 / 55 / 194 cm</p>  <p>(Suggestions always without extra charge articles)</p>	Accent	Glass anthracite	Loden (MG/MB/MT)
	Extra charge lighting - Switch		
	Extra charge lighting - Remote & Dimmer		
	Extra charge drawer 128 instead of hatch for Lowboard		
	Extra charge Cable management for Lowboard		
<p>Suggestion (ill.)comprises: 1x Display cabinet 96 with accent, 2 doors, glass right                  1x Lowboard 192/34, 1 hatch, 1 drawer, accent drawer left                  1x Suspended display cabinet 64/128, 1 door, door stop right                  2x Wall panel with glass shelf 128 cm</p>			

## SALES AND SHIPMENT TERMS AND CONDITIONS

### 1. General

1.1. The terms and conditions of sale and shipment as detailed below are valid for all business relationships (such as purchasing agreements, contracts of work and labour, fitting agreements, etc.) between VOGLAUER MOBELWERK Gschwandtner & Zwilling GmbH & Co KG, hereinafter referred to as VOGLAUER, and its customers. Customers accept these terms as binding upon them by placing an order or closing a contract with VOGLAUER. Deviating, conflicting or amending General Terms, whether known to VOGLAUER or not, cannot become part of any contract with VOGLAUER except by express written acceptance. Inasmuch as conditions deviating from these terms and conditions of sale and shipment are agreed to in writing as part of a contract, the stipulations of the contract have priority.

1.2. VOGLAUER closes contracts strictly only with registered companies. Should in exceptional cases a customer be a consumer in the sense of consumer protection laws, such customers have the obligation to notify VOGLAUER of that fact. Otherwise, such customers will be held liable. These terms and conditions of sale and shipment will be valid for business with consumers only as far as they are in compliance with imperative stipulations of consumer protection laws.

### 2. Proposal, Prices

2.1. All prices quoted by VOGLAUER in proposals and price lists are non-binding and net prices except if and where it is clearly indicated that VAT is included. Prices quoted by VOGLAUER are free buyer's address, fitting excluded. VAT will be calculated separately on the basis of the legal provisions valid on the day of delivery or performance of services. VOGLAUER reserves the right to perform technical and other changes within reason. Purchase orders without prices will be processed using the applicable list prices valid the day of arrival of the order.

2.2. If goods or services are delivered later than the agreed date for reasons other than late delivery culpably caused by VOGLAUER, VOGLAUER has the right to raise the prices accordingly. Such price correction will take into account changes of labour costs according to collective treaties and actual costs for performance such as costs of material, energy, transport, financing of external services, etc. between agreed and actual delivery dates.

2.3. Export deliveries will always be charged and payable in Euros. In cases where payment is expressly agreed in a different currency, invoicing will be on the basis of the exchange rate valid on the date of order acknowledgement by VOGLAUER. For this calculation, only exchange rates calculated by Austrian banks will be relevant.

### 3. Order Acceptance, Subject Matter of Orders

3.1. Purchase orders issued to VOGLAUER will result in a contractual relationship only by written order acknowledgement or delivery of goods or of an invoice by VOGLAUER. Customers have the obligation to provide comprehensive and correct documentation required for the production of the goods (measurements, blueprints, etc.) with the purchase order. Additional costs possibly inflicted by deviation of the actual situation from the documents or blueprints provided by customers as well as additional costs resulting from late provision of such documents will be carried by the customer. Changes to accepted orders will only be possible by written consent.

3.2. If at the time of order placement the ordered goods are not fully specified in all detail (especially technically), a preliminary order acknowledgement will be issued. Customers have the obligation to deliver further detail (actual measurements, etc.) in such time as to allow delivery on time. Upon delivery of the details, a final order acknowledgement will be issued which determines the subject matter of the contract in a binding fashion unless customers send their dissent in writing immediately. If so, the delivery contract will remain valid as by the preliminary order acknowledgement. In case of changes to an order communicated after a preliminary order acknowledgement has been issued, the prices will be adapted to a possibly precursory estimate.

### 4. Shipment, Delivery

4.1. Unless agreed otherwise, delivery will be free customer's address. Transport insurance will be closed only if expressly requested by the customer. Costs arising from this will be carried by the customer. Unless agreed otherwise in writing, peril of price will be transferred to the customer at the time of shipment of the goods, or in case of late acceptance by the customer, at the time of readiness for shipment by VOGLAUER.

4.2. Unless agreed otherwise in writing, the choice of the place of shipment and the way and means of transport is in VOGLAUER's best discretion, without acceptance of any liability for cheapest or fastest transport. Delivery dates will in any event be non-binding unless expressly agreed to the contrary.

4.3. As a matter of principle, the agreed delivery periods are counted from the date of order acknowledgement. If VOGLAUER is at that time (start of lead time) not in possession of the documentation required for production such as especially actual room measurements, lead time starts at the date of receipt by VOGLAUER of the last document required. Customers have the obligation to provide such documentation in a timely manner. Delivery dates (lead times) will be extended by fitting delays not caused by VOGLAUER. In case a down payment is to be made by the customer, the lead-time will not be counted before the day of its receipt by VOGLAUER.

4.4. If acceptance of the delivered goods by the customer is delayed, whether culpably or otherwise, VOGLAUER has the right to ask a storage charge to an amount customary in the place; Furthermore, VOGLAUER has the right to withdraw from the delivery contract, upon which the customer has to pay the difference between the agreed price and the expectable revenue from realisation of the deliverable goods. In case of included fitting, customers have the obligation to accept the contractual items immediately after completion in a visit. If acceptance is denied, the purchased goods are deemed accepted.

4.5. In case that VOGLAUER fails to meet delivery dates by more than 3 weeks, customers have the right to withdraw from the contract after a reasonable period of grace. If such delay is due to operational reasons VOGLAUER cannot prevent with due diligence of a scrupulous merchant (especially strike, disruption, raw material shortage, etc.), customers will be entitled to withdraw from the contract after a two-month delay after a reasonable period of grace.

### 5. Withdrawal from Contract

5.1. If a customer fails to fulfil contractual obligations in full or in part, VOGLAUER has the right to withdraw from the contract. The right to withdraw from the contract can be declared for only part(s) of the goods to be delivered. In such cases, VOGLAUER has the obligation to deliver the part of the shipment which is not affected by the withdrawal and customer has the obligation to make payment for that part.

5.2. If VOGLAUER withdraws from a contract for reasons for which the customer is answerable without necessarily being culpable, or if customer withdraws from a contract without being entitled to do so, customer has the obligation to cover the costs of preparatory efforts by VOGLAUER (material purchased, special services, labour expenditure, etc.). VOGLAUER has the choice between the right to charge a lump sum of 25 % of the total amount of the contract without provision of specific evidence for individual efforts. Custom designs already produced by VOGLAUER must be paid for in full minus fitting and shipment costs.

### 6. Fitting

6.1. In cases where fitting is part of the agreement, customer has the obligation to provide for orderly vehicle access all the way to the rooms to be furnished. Where means of transportation such as cranes and lifts exist, these will be provided for use by VOGLAUER or its subcontractors free of charge.

6.2. Customer accepts liability for storage of the delivered goods on the construction site. This specifically includes theft-protected and dry storage on the construction site.

6.3. Customer will make all necessary provisions so that fitting can be performed without delay; specifically that assembly fitters not be hampered by other craftspeople. Also, the fitting areas of the rooms to be furnished must be heated, clean and sufficiently lighted where required and electric power is to be provided. Costs for electricity and water will be carried by the customer. Carpeted floors must be made slippery-proof and sufficiently covered to prevent soiling and damage by the customer.

6.4. If fitting includes connections with objects owned by the customer or third parties (e.g. Fastening to walls by drilling or chiselling), customer will warn VOGLAUER of perilous locations prior to the commencement of such work, specifically the exact location of electric cables, gas and water pipes and other supply systems will be communicated.

6.5. VOGLAUER has no obligation to inspect the properties of walls or objects to which VOGLAUER parts will be connected. Customer, on the other hand, has the obligation to notify VOGLAUER of properties of walls or objects possibly impairing simple and problem-free fitting. Any additional work and expense resulting from unpredicted properties of walls and objects will be charged to the customer.

6.6. Additional costs for overtime authorized and fitting delays caused by the customer as well as work not included in the order acknowledgement or work caused by inadequate environment will be charged separately. This will also be the case if VOGLAUER has offered fitting for a lump sum or for free as a discount.

6.7. Customer will at their own costs take care of cleaning of the rooms after fitting. Lack of contractual stipulations to the contrary, fitting services offered by VOGLAUER do not include fitting and connecting of electric equipment of any kind and lighting appliances. Unless agreed otherwise, such work is to be performed by authorized craftsmen at customer's own expense. Packaging material will be disposed of by the customer at his or her own expense.

### 7. Notification of Defects

Upon delivery, customers must immediately inspect the goods for possible defects. Incomplete or wrong shipments as well as complaints for recognisable defects will be directed to VOGLAUER in writing immediately upon receipt of the goods, non-recognisable defects immediately upon their discovery. The notification must indicate clearly the kind and extent of the alleged defect. In case of late notification of defects and errors, the shipment will be considered approved, in which case warranty claims are ruled out.

## 8. Warranty

VOGLAUER provides warranty for the delivered goods for a period of one year from the shipment date. For electric implements and lighting appliances delivered by VOGLAUER, the warranty period will be six months. In cases of justified and timely notification of defects, VOGLAUER will, reasonably taking into account customer's interest, provide warranty by improvement, price reduction or replacement (exchange) or take back the goods refunding the purchase price. The choice of the warranty method is VOGLAUER's. If VOGLAUER fails to meet warranty obligations within reasonable time, customer has the right to a reasonable price reduction or to withdraw from the contract. Activities started by VOGLAUER due to unjustified notifications of defect are considered purchase orders, and customers have the obligation to pay for the services rendered thereunder.

Excluded from the warranty are specifically:

- Goods provided by the customer;
- Damages resulting from deficiencies of the environment (e.g. faulty walls, construction material moisture, construction deficiencies, etc.);
- Compatibility of material used by VOGLAUER with other parts and properties of the rooms to furnish, such as other furnishing, lighting colours, heating, etc.;
- Deformation and crevices of massive wood used;
- Function of the delivered goods and suitability of the material used if the design has been made by the customer or his agent (e.g. architect);
- Minor deviations of hues and surface or veneer structures of the delivered goods;

## 9. Exclusions from Liability

9.1. VOGLAUER can be held liable for damages outside of the applicability of the product liability law only in cases of intent or gross negligence. Liability for slight negligence is foreclosed, as is compensation for consequential damage and financial loss, failure to realise savings or profit, losses from interest and damages from third party claims against the customer.

9.2. Within the applicability of the product liability law, VOGLAUER will be liable for personal damage and for material damage suffered by consumers. VOGLAUER will not be liable for material damage suffered by companies. Regress by the customer as defined in § 933b ABGB (Austrian General Law) is excluded. Claims for damages are in any event limited to a three-year period, counted from shipment.

9.3. The parties to a contract also mutually renounce all claims for any damages covered by an insurance held by the damaged party. This renunciation will not extend to damages inflicted by intent or gross negligence or if the insurer would be exempt from indemnification as a consequence of such renunciation.

9.4. Locking mechanisms or safe deposits provided by VOGLAUER will not constitute theft or break-in protection so that claims for damages resulting from these are excluded. A possibly required anti-theft device will therefore be acquired by the customer at his or her own cost and risk; VOGLAUER will not be held liable for locked items.

## 10. Payment

10.1. Invoices for the delivery of goods will be sent by email and are payable according to the stipulations of the individual contract. Unless stipulated otherwise, the customer will pay one third of the total amount quoted in the order acknowledgement as a down payment promptly upon order placement, one third two weeks prior to readiness for shipment and the remaining amount immediately upon receipt of the final invoice without discount. As far as there is no written agreement between the parties to a contract with regards to terms of payment, the amounts invoiced are payable directly upon receipt of the invoices without discounts. Bills of exchange or cheques will be accepted only on the grounds of separate written agreement and solely as payment. Discount and exchange expenses will be payable immediately by the customer. The customer recognises that VOGLAUER field staff are not entitled to collect payment.

10.2. In case of delayed payment, interest for delay amounting to 8 % above the then current base-lending rate will be charged. Set-off by the customer is ruled out except with receivables accepted in writing by VOGLAUER or ascertained in a legally binding manner.

10.3. If a customer cannot continue orderly business operations or forced sale of collaterals is in progress, if an act of protest is ongoing or delay or stop of payments is prevailing or if the customer has filed in or out of courts for a settlement system or bankruptcy has been declared, whether successful or not, VOGLAUER has the right to declare all outstanding bills from the business relationship due immediately, even if bills of exchange or cheques have been accepted or payment by instalments has been agreed. This also applies if and when the customer is late with payment or other circumstances indicate towards a questionable creditability. Furthermore, VOGLAUER has in the above-mentioned cases the right to demand advance payment or securities, realise securities provided or withdraw from the contract, claiming damages for default of performance.

10.4. Customers do not have the right to withhold payment due to alleged deficiencies, except if such deficiencies and the withholdable amounts have been accepted in writing by VOGLAUER or ascertained by a legal court. Any cession of customer receivables against VOGLAUER to third parties as well as any cession of rights and obligations of the closed contract is prohibited without prior written consent by VOGLAUER.

## 11. Reservation of Property Rights

11.1. The goods delivered remain the sole property of VOGLAUER until fulfilment of all obligations of the customer, specifically full payment of the purchase price including all side costs and interest, dues, fees, etc

11.2. Goods delivered for a particular building project, even if ordered, delivered and invoiced in tranches, are considered one coherent order. In such cases the reservation of property rights to all goods delivered will expire only when all payments resulting from the contracts therein have been made in full.

11.3. The customer has the right to sell goods delivered under this reservation of property rights only if they are dedicated goods for resale or after the reservation of property rights has expired or VOGLAUER expressly authorizes such sale. In case of resale of goods, the customer will cede all claims resulting from such sale to VOGLAUER. The customer has the obligation to make such cession recognizable by corresponding entries in his or her books and to disclose to VOGLAUER upon request the names of the debtors as well as to precisely specify the cessed receivables. The cession will be accepted by VOGLAUER. Any dues or taxes related to such cession are to be carried by the customer, who will indemnify VOGLAUER of claims resulting thereof. VOGLAUER retains the right to disclose the cession and to realise the receivables cessed directly.

11.4. The customer has the obligation to sufficiently cover the reserved goods by insurance against common risks such as elementary events and to provide proof of such cover to VOGLAUER upon request. The customer hereby cedes given insurance claims to VOGLAUER. The customer also has the obligation to store the goods according to instructions given by VOGLAUER and to the state of the art. The customer has the obligation to tend to the goods during the reservation of property rights.

11.5. The customer will immediately notify VOGLAUER of access to the goods under reservation of VOGLAUER property rights by third parties (execution or listing for execution, other court orders or enactments). The customer will support and assist VOGLAUER in legal attempts to protect VOGLAUER's rights to the property and carry all associated costs if the customer has inflicted the threat to reserved VOGLAUER property.

11.6. In case of connection or mingling of reserved VOGLAUER property with other goods, VOGLAUER will gain joint ownership in the resulting goods proportionally to the value of the reserved property with respect to the value of the other goods at the time of connection or mingling. In case of sale of the resulting matter, the customer will cede the aliquot sales price in the sense of the stipulation above to VOGLAUER.

## 12. Intellectual Property

Trade marks, representations and the associated sketches, plans and descriptions are the intellectual property of VOGLAUER and must not be copied or disclosed to third parties without prior written consent by VOGLAUER.

## 13. Advertising

It is accepted that objects furnished by VOGLAUER may be used by VOGLAUER for purposes of advertising (reference lists, brochures, press releases, etc.) quoting customer names and using pictures of the furnished objects. The customer grants VOGLAUER the right to take pictures of the furnished objects.

## 14. Force Majeure

Events of force majeure affecting VOGLAUER or any of VOGLAUER's suppliers constitute the right for VOGLAUER to suspend deliveries for the duration of the hampering circumstances plus a reasonable lead-time without such suspension constituting a delay or the right for customers to fully or partially withdraw from the contract.

Events of force majeure are, among other things: All effects of the forces of nature such as earthquake, lightning, frost, storm, flood; furthermore, war, legal action, enactments by local authorities, detention, transport disruption, export, import or transit bans, international payment restrictions, raw material shortage and power loss; furthermore, operational disruptions such as explosion, fire, strike, sabotage and all other events which could not be prevented other than by unreasonably high costs or means not economically justifiable.

## 15. Data Privacy Assent

The customer expressly agrees that collection, processing and use of personal data provided by the customer be used by VOGLAUER for marketing purposes by installation of a customer data base and related activities. This assent specifically includes information transfer for purposes of advertising by fax, letter, email or any other method. This assent can be withdrawn by customers at all times with immediate effect for the future.

## 16. Final Provisions

16.1. All contracts closed by and with VOGLAUER as well as these terms and conditions are governed exclusively by Austrian law with the exclusion of the delegation norms and the UN convention on contract for the international sale of goods. All disputes arising directly or indirectly from contracts with VOGLAUER will be regulated at the appropriate court in the city of Salzburg, Austria. Place of performance for delivery and payment will be the principal office of VOGLAUER.

16.2. In case one or more of the stipulations herein or in a contract become invalid in full or in part, validity of the remaining stipulations will remain untouched. Fully or partly invalid stipulations will be considered replaced by provisions whose economical success approximates closest the original stipulation(s).

16.3. All changes or amendments of contracts between VOGLAUER and customers must be in writing, including the agreement to waive this stipulation. All declarations by VOGLAUER will only be legally binding if they are issued in writing by staff of the VOGLAUER principal office at Abtenau, Austria.



# Design. Nature. Handcraft.



A commitment to nature and quality for over 80 years.

## Innovative with consideration of the green and social environment



### Ecolabels for

- Raw material and energy consumption
- Tested ingredients
- Emissions
- Disposal / recycling
- Packaging
- Power generation through in-house hydropower

### Own hydropower



- Power generation through in-house hydropower

60 % of the energy consumption in production is covered by our own hydropower!

### Energy/Recycling



- Thermal utilisation of 95 % of the wood waste
- Recycling of all water-based lacquers and wood strippers
- Energy comes from renewable energy sources
- Conscious waiver of air conditioning systems due to special night-ventilation system

### Social responsibility



- Voglauer Academy – Training of the employees
- Free Shuttle-Service for employees
- Company cafeteria
- Support of public safety organisations



Wood from sustaining sources

Furniture – pure and genuine



Oak

## WOODEN FURNITURE for a pleasant atmosphere



# VOGLAUER FURNITURE LINES



V-Solid / NEW 2015

- Dining
- Living



V-Alpin

- Dining
- Living
- Hall



V-Montana

- Dining
- Living
- Hall



V-Loft

- Dining
- Living



V-Vita

- Dining
- Living
- Hall



V-Soft

- Dining
- Living



V-Pur / NEW 2015

- Sleeping



V-Rivera

- Sleeping

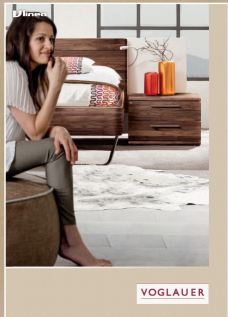

V-Linea

- Sleeping

Request desired folders either by telephone or on our homepage.  
It will be a pleasure for us to send them to you for free.

Voglauer traders:

You would like further information about our business or product lines? If so, please visit us online [www.voglauer.com](http://www.voglauer.com).



Follow us on Facebook!  
Regular News from VOGLAUER.

Voglauer Möbelwerk Gschwandtner & Zwilling GmbH & Co KG  
A-5441 Abtenau / Salzburger Land | Tel. +43 6243 2700-0 | Fax DW-210  
Email: [office@voglauer.com](mailto:office@voglauer.com) | [www.voglauer.com](http://www.voglauer.com)