

VOGLAUER

Uloft



MODELS REGISTER

(valide from April 2015)

Please always indicate the following specifications:

MODEL: V-Loft **LO**

TYPE OF WOOD:



Wild oak, oiled EG



Wild nut, oiled UW

LIGHTING:



LED-light with switch F-LS



LED-light remote switch F-LF

LODEN (fabric for upholstery): (Indicate loden number and description)



grauweiß MG



basaltgrau MB



tundrabraun MT

GLASS SLIDING FRONT OF SHELF UNITS:



coloured glass grandbrown G



coloured glass optiwhite O

LEATHER (fabric for upholstery): (Indicate leather number and description)



sahne LW



ziegelrot LY

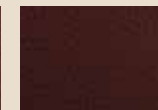

burgundy LX

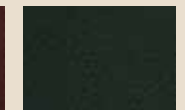

army green LZ



cognac LV



caffé LU

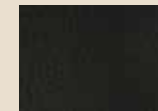

testa di moro LT

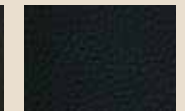

schwarz LS



kiesel LK



coco LO



stone LM



cenere LP

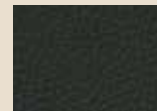

anthrazit LN

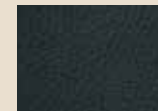

oceano LL

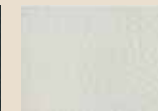

reinweiß LR

The colour samples are not suitable as color samples.

REFERENCE NUMBER:

Please indicate each article by its reference number.

Attention: Indicate article-specific complements!

Ordering example:

- FS22T-L UW** Sideboard 229, Glass sliding door left, Wild nut oiled, W/D/H 229/53,8/88 cm
- F-LS** Lighting per switch
- F-F** Rear panel made of spruce
- FE1624 EG+MB** Upholstered corner, Wildoak oiled, Loden MB basalt grey, Side length L/R 162/242 cm
- FTS118 EG** Table, Feet transversal, Wildoak oiled, W/L 100/180 cm
- F-5KS** Surcharge Elongation 48,5 cm

ORDER MANAGEMENT AND TECHNICAL SUPPORT: Fax Nr.: +43 (0) 6243 2700 - 359



Daniel WALLINGER
Tel. +43 (0) 6243 2700-355
daniel.wallinger@voglauer.com



Andreas FEISER
Tel. +43 (0) 6243 2700-352
andreas.feiser@voglauer.com



Theresa WINTERSTELLER
Tel. +43 (0) 6243 2700-377
theresa.wintersteller@voglauer.com



Michael RESCHREITER
Tel. +43 (0) 6243 2700-357
michael.reschreiter@voglauer.com



Andrea GSENGER
Tel. +43 (0) 6243 2700-450
andrea.gsenger@voglauer.com

DELIVERY DATE INFORMATION: Fax: +43 (0) 6243 2700 - 315

Delivery: 5-7 weeks after having obtained commission

Helmut POSCH: helmut.posch@voglauer.com

Johann STEINER: johann.steiner@voglauer.com

VOGLAUER – CERTIFICATIONS AND AWARDS



Structural Design / Loading Capacities:

| | | | |
|--------------------------|---|-------------|--|
| Corpus: | Corpus parts CLV board veneered with genuine wood (Rounded side plates and panels according to articles on page 11, solid wood) | | |
| Fronts: | Solid wood, Glass sliding doors with colour glass, satinised | | |
| Shelf rows: | Wooden shelf rows behind wooden doors, bronzed glass shelf rows behind transparent front glasses (6mm - ESG). | | |
| Front glass: | All front glasses in browned (Parsol bronze) glass ESG (toughened safety glass), 6mm | | |
| Drawers: | Dovetailed solid wood drawers (beech) with covered, smooth-running | | |
| Aluminium profile: | Aluminium anodised (A6/C34-brown) | | |
| Dining tables: | Framework solid wood | | |
| Seating bench: | Framework solid wood, Seat and backrest upholstered with cattle hide napa leather | | |
| Loading capacity: | Glass shelf rows 6 mm: | max. 5 kg | Drawers (until 90 cm in width): max. 10 kg |
| | Wooden shelf rows: | max. 20 kg | Drawers (more than 90 cm in width): max. 25 kg |
| | Cantilever chairs: | max. 120 kg | |

LED-Lighting (optional):

All lighting systems are installed and wired securely in(to) the furniture by VOGLAUER. Every illuminated element has its own controller and/or transformer and a power cable (approx. 2,5m) with EURO-plug. The lamps (illuminant) cannot be replaced in the fixtures.

Optional lighting:

- with internal light switch
- with remote-controlled radio circuit (every element comes with its own handheld transmitter - subsequently several lighting systems can be adapted to one single transmitter)

Energy efficiency grade: A - A++

Performance/Consumption: LED-Strype: 4,8 Watt/rm

Wood Composites - Indoor Climate:

Despite accurate processing wood is a living raw material; standing in reaction with air humidity and adapts to climatical conditions. Different colours, structures, small shakes, slight warping or open knots can be unavoidable consequences. An ideal indoor climate for wooden furniture would be approximately 18-23° C and 44-55 % air humidity. In order to avoid shakes and warpings, solid wood furniture should undergo low variability of the climate.

Oiled Surfaces:

All Voglauer surfaces equate to organic products concerning their environmental compatibility and ecology. The oiled surface is breathable and improves the indoor climate. The surface is antistatic, i.e. dust- and dirt-repellent.

Maintenance of oiled surfaces: To maintain the oiled Voglauer furniture's worth, it is advisable to oil it more or less every 6-8 months. Apply the Voglauer maintenance set (see: additional - „Maintenance oil“) thinly with a smooth, not fraying cloth and spread it evenly in fibre direction. Afterwards polish it with a dry cotton cloth. The surface will shine silk and velvety.

Upholstery - Loden - Leather:

- Loden of 100% virgin wool
- Heavy-weight soft cattle hide napa leather with expressive grain.
- Each skin is unique and has undergone many production steps, hence slight colour differences are inevitable. This must be taken into account especially when comparing original furniture to their samples.
- Wrinkling is a natural procedure and therefore no decrease in quality. It occurs as a consequence of the leather's using or stretching.

Important Planning Advices:





- Check out constructional conditions, obstructions, measures and resilience at determination of material requirements to ensure a performance free of defects.
- Check out electrical conditions for connections and engineering (freely suspended lighting systems require cable ducts on or under plaster). Every illuminated element has its own power cable (approx. 2,5 m) with EURO-plug. In carcass furniture power connection for lighting (power point, cable exit) can be entirely located behind the rear panel (distance to wall approx. 23 mm).
- The door hinges are nickel-plated and 3-dimensional adjustable. Essential for the door's exact matching is to place the furniture on a flat bottom - in case of unevenness furniture items can be compensated with the included furniture wedges.
- All declared values in the price list are theoretical approximate dimensions and due to the aggregate tolerances they deviate from the real dimensions. The total dimensions don't comprehend handles and other irrelevant protruding component parts.



Installation of the Furniture:

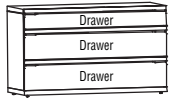
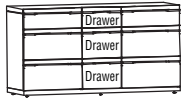

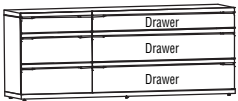
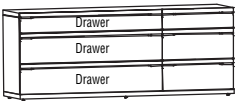
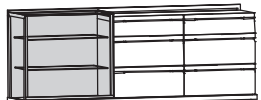
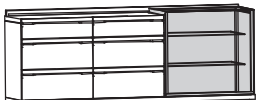
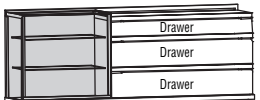
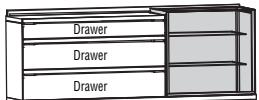

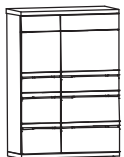
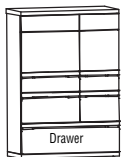
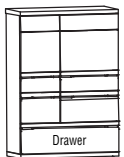

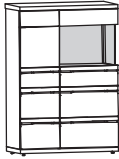
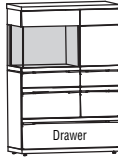
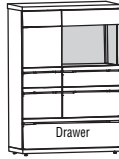

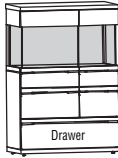
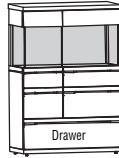
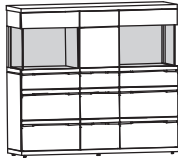
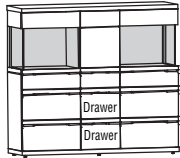
Due to the big doors and full-opening drawers, furniture's standing on the ground has to be attached to the wall, to pretend it from tilting over. VOGLAUER includes the compatible installation-equipment for firm masonry. For drywalls / metal-stud walls the technician has to get compatible dowels and screws by himself. VOGLAUER don't assume any liability for the installation. Every furniture from Voglauer is assembled and performed individually. Some bulky goods are delivered in separate pieces. There are mounting instructions for not assembled goods (e.g. shelf units)





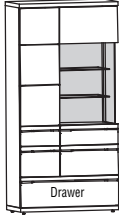





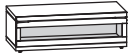

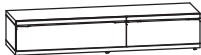
VOGLAUER Furniture Quality Certificate:

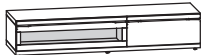



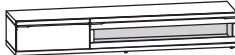

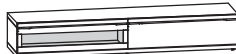

Every consignment comes with a VOGLAUER quality certificate (Online Download: www.voglauer.com). VOGLAUER do not assume any liability for not conforming to care and maintenance instructions or misuse.

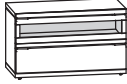
| | | | | |
|-----------------------------|---|--|---|---|
| | <p>1 Shelf row</p>  <p>W/D/H 141/50/82,6 cm</p> | <p>1 Shelf row</p>  <p>W/D/H 141/50/82,6 cm</p> | <p>a 1 Shelf row, left and right</p>  <p>W/D/H 154,8/50/82,6 cm</p> | |
| Description | Sideboard 141, 2 Doors | Sideboard 141, 3 Drawers | Sideboard, 2 Doors, 3 Drawers in the middle | |
| WILD OAK | | | | |
| WILD NUT | | | | |
| | <p>left: 1 door, 1 shelf row, right: 2 doors, 1 shelf row</p>  <p>W/D/H 211,4/50/82,6 cm</p> | <p>1 Shelf row on the left side</p>  <p>W/D/H 211,4/50/82,6 cm</p> | <p>1 Shelf row on the right side</p>  <p>W/D/H 211,4/50/82,6 cm</p> | |
| Description | Sideboard 211, 3 Doors | Sideboard 211, 3 Drawers, 1 Door left | Sideboard 211, 3 Drawers, 1 Door right | |
| WILD OAK | | | | |
| WILD NUT | | | | |
| | <p>left: 2 fixed glass shelf rows right: 2 doors, 1 shelf row</p>  <p>W/D/H 229/53,8/88 cm</p> | <p>left: 2 doors, 1 shelf row, right: 2 fixed glass shelf rows</p>  <p>W/D/H 229/53,8/88 cm</p> | <p>2 fixed glass shelf rows on the left side</p>  <p>W/D/H 229/53,8/88 cm</p> | <p>2 fixed glass shelf rows on the right side</p>  <p>W/D/H 229/53,8/88 cm</p> |
| Description | Sideboard 229, 2 Doors, Glass sliding door left | Sideboard 229, 2 Doors, Glass sliding door right | Sideboard 229, 3 Drawers, Glass sliding door left | Sideboard 229, 3 Drawers, Glass sliding door right |
| WILD OAK | | | | |
| WILD NUT | | | | |
| Lighting per switch | | | | |
| Lighting per radio + dimmer | | | | |
| Rear panel made of spruce | | | | |
| | <p>3 Shelf rows</p>  <p>W/D/H 97/43/140,2 cm</p> | <p>3 Shelf rows</p>  <p>W/D/H 97/43/140,2 cm</p> | <p>2 Shelf rows</p>  <p>W/D/H 97/43/140,2 cm</p> | <p>2 Shelf rows</p>  <p>W/D/H 97/43/140,2 cm</p> |
| Description | Highboard 97, 2 Wooden doors, wide door left | Highboard 97, 2 Wooden doors, wide door right | Highboard 97, 2 Wooden doors, 1 Drawer, wide door left | Highboard 97, 2 Wooden doors, 1 Drawer, wide door right |
| WILD OAK | | | | |
| WILD NUT | | | | |

| | | | | |
|-----------------------------|---|---|--|--|
| | <p>left: 2 fixed shelf rows, 1 shelf row, right: 3 shelf rows</p>  <p>W/D/H 97/43/140,2 cm</p> | <p>left: 3 shelf rows, right: 2 fixed shelf rows , 1 shelf row</p>  <p>W/D/H 97/43/140,2 cm</p> | <p>left: 2 fixed shelf rows , right: 2 shelf rows</p>  <p>W/D/H 97/43/140,2 cm</p> | <p>left: 2 shelf rows, right: 2 fixed shelf rows</p>  <p>W/D/H 97/43/140,2 cm</p> |
| Description | Highboard 97, 2 Doors, Glass left | Highboard 97, 2 Doors, Glass right | Highboard 97, 2 Doors, 1 Drawer, Glass left | Highboard 97, 2 Doors, 1 Drawer, Glass right |
| WILD OAK | | | | |
| WILD NUT | | | | |
| Lighting per switch | | | | |
| Lighting per radio + dimmer | | | | |
| Rear panel made of spruce | | | | |
| | <p>2 fixed shelf rows , 1 Shelf row</p>  <p>W/D/H 97/43/140,2 cm</p> | <p>2 fixed shelf rows , 1 Shelf row</p>  <p>W/D/H 97/43/140,2 cm</p> | <p>2 fixed shelf rows</p>  <p>W/D/H 97/43/140,2 cm</p> | <p>2 fixed shelf rows</p>  <p>W/D/H 97/43/140,2 cm</p> |
| Description | Highboard 97, 2 Glass doors, wide door left | Highboard 97, 2 Glass doors, wide door right | Highboard 97, 2 Glass doors, 1 Drawer, wide door left | Highboard 97, 2 Glass doors, 1 Drawer, wide door right |
| WILD OAK | | | | |
| WILD NUT | | | | |
| Lighting per switch | | | | |
| Lighting per radio + dimmer | | | | |
| Rear panel made of spruce | | | | |
| | <p>external: a 2 fixed shelf rows, 1 shelf row in the middle: 3 shelf rows</p>  <p>W/D/H 154,8/43/140,2 cm</p> | <p>external: a 2 fixed shelf rows, 1 shelf row, in the middle: 1 shelf row</p>  <p>W/D/H 154,8/43/140,2 cm</p> | | |
| Description | Highboard 155, 3 doors, Glass external | Highboard 155, 3 doors with 2 Drawers, Glass external | | |
| WILD OAK | | | | |
| WILD NUT | | | | |
| Lighting per switch | | | | |
| Lighting per radio + dimmer | | | | |
| Rear panel made of spruce | | | | |

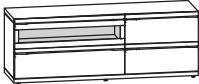
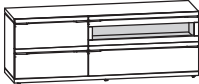

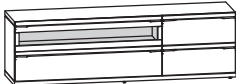

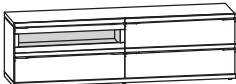
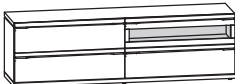
| | | | | |
|-----------------------------|---|---|--|---|
| | <p>2 fixed shelf rows , 1 Shelf row, 2 fixed glass shelf rows</p>  <p>W/D/H 70,6/43/197,8 cm</p> | | <p>2 fixed shelf rows , 2 fixed glass shelf rows</p>  <p>W/D/H 70,6/43/197,8 cm</p> | |
| Description | Glass cabinet 70, 1 door, Door stop left | Glass cabinet 70, 1 door, Door stop right | Glass cabinet 70, 1 door with drawer, Door stop left | Glass cabinet 70, 1 door with drawer, Door stop right |
| WILD OAK | | | | |
| WILD NUT | | | | |
| Lighting per switch | | | | |
| Lighting per radio + dimmer | | | | |
| Rear panel made of spruce | | | | |
| | <p>left: 2 fixed shelf rows 1 Shelf row 2 fixed glass shelf rows right: 4 Shelf rows</p>  <p>W/D/H 97/43/197,8 cm</p> | <p>left: 4 Shelf rows right: 2 fixed shelf rows 1 Shelf row 2 fixed glass shelf rows</p>  <p>W/D/H 97/43/197,8 cm</p> | <p>left: 2 fixed shelf rows 2 fixed glass shelf rows right: 3 Shelf rows</p>  <p>W/D/H 97/43/197,8 cm</p> | <p>left: 3 Shelf rows right: 2 fixed shelf rows 2 fixed glass shelf rows</p>  <p>W/D/H 97/43/197,8 cm</p> |
| Description | Glass cabinet 97, 2 Doors, Glass left | Glass cabinet 97, 2 Doors, Glass right | Glass cabinet 97, 2 Doors, 1 Drawer Glass left | Glass cabinet 97, 2 Doors, 1 Drawer, Glass right |
| WILD OAK | | | | |
| WILD NUT | | | | |
| Lighting per switch | | | | |
| Lighting per radio + dimmer | | | | |
| Rear panel made of spruce | | | | |
| | <p>2 fixed shelf rows 1 Shelf row 2 fixed glass shelf rows</p>  <p>W/D/H 97/43/197,8 cm</p> | <p>2 fixed shelf rows 1 Shelf row 2 fixed glass shelf rows</p>  <p>W/D/H 97/43/197,8 cm</p> | <p>2 fixed shelf rows 2 fixed glass shelf rows</p>  <p>W/D/H 97/43/197,8 cm</p> | <p>2 fixed shelf rows 2 fixed glass shelf rows</p>  <p>W/D/H 97/43/197,8 cm</p> |
| Description | Glass cabinet 97, 2 Glass doors, wide door left | Glass cabinet 97, 2 Glass doors, wide door right | Glass cabinet 97, 2 Glass doors, 1 Drawer, wide door left | Glass cabinet 97, 2 Glass doors, 1 Drawer, wide door right |
| WILD OAK | | | | |
| WILD NUT | | | | |
| Lighting per switch | | | | |
| Lighting per radio + dimmer | | | | |
| Rear panel made of spruce | | | | |

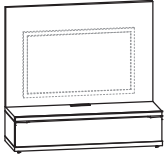
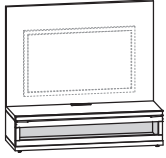
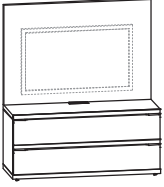
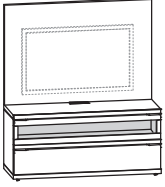

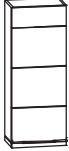
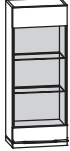
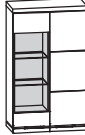
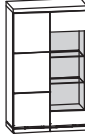

| | | | | |
|---|---|--|---|---|
| |  |  |  |  |
| | W/D/H 105,8/50/34,6 cm | W/D/H 105,8/50/34,6 cm | W/D/H 141/50/34,6 cm | W/D/H 141/50/34,6 cm |
| Description | Lowboard 106/35, 1 Hatch | Lowboard 106/35, 1 Glass hatch | Lowboard 141/35, 1 Hatch | Lowboard 141/35, 1 Glass hatch |
| WILD OAK | | | | |
| WILD NUT | | | | |
| Drawer instead of hatch | | no drawer instead of hatch possible! | | no drawer instead of hatch possible! |
| Cable management - Hatch incl. plug connector | | | | |
| |  |  |  |  |
| | W/D/H 176,2/50/34,6 cm | W/D/H 176,2/50/34,6 cm | W/D/H 176,2/50/34,6 cm | W/D/H 176,2/50/34,6 cm |
| Description | Lowboard 176/35, 2 Hatches, wide hatch left | Lowboard 176/35, 2 Hatches, wide hatch right | Lowboard 176/35, 2 Hatches, Glass hatch left | Lowboard 176/35, 2 Hatches, Glass hatch right |
| WILD OAK | | | | |
| WILD NUT | | | | |
| Drawer 70 instead of hatch | | | | |
| Drawer 106 instead of hatch | | | no drawer instead of hatch possible! | |
| Cable management - Hatch incl. plug connector | | | | |
| |  |  |  |  |
| | W/D/H 211,4/50/34,6 cm | W/D/H 211,4/50/34,6 cm | W/D/H 211,4/50/34,6 cm | W/D/H 211,4/50/34,6 cm |
| Description | Lowboard 211/35, 2 Hatches, wide hatch left | Lowboard 211/35, 2 Hatches, wide hatch right | Lowboard 211/35, 2 Hatches, Glass hatch left | Lowboard 211/35, 2 Hatches, Glass hatch right |
| WILD OAK | | | | |
| WILD NUT | | | | |
| Drawer 70 instead of hatch | | | | |
| Drawer 141 instead of hatch | | | no drawer instead of hatch possible! | |
| Cable management - Hatch incl. plug connector | | | | |
| |  |  |  | |
| | W/D/H 211,4/50/34,6 cm | W/D/H 211,4/50/34,6 cm | W/D/H 211,4/50/34,6 cm | |
| Description | Lowboard 211/35, 2 Hatches | Lowboard 211/35, 2 Hatches, Glass hatch left | Lowboard 211/35, 2 Hatches, Glass hatch right | |
| WILD OAK | | | | |
| WILD NUT | | | | |
| Drawer 106 instead of hatch | | | no drawer instead of hatch possible! | |
| Cable management - Hatch incl. plug connector | | | | |

| | | | | |
|---|---|--|---|---|
| |  |  |  |  |
| | W/D/H 105,8/50/63,4 cm | W/D/H 105,8/50/63,4 cm | W/D/H 141/50/63,4 cm | W/D/H 141/50/63,4 cm |
| Description | Lowboard 106/63, 2 Hatches | Lowboard, 1 Glass- 1 Woodenhatch | Lowboard 141/63, 2 Hatches | Lowboard, 1 Glass- 1 Woodenhatch |
| WILD OAK | | | | |
| WILD NUT | | | | |
| Drawer instead of hatch at the top | | no drawer instead of hatch possible! | | no drawer instead of hatch possible! |
| Drawer instead of hatch at the bottom | | | | |
| Cable management - Hatch incl. plug connector | | | | |
| |  |  |  |  |
| | W/D/H 176,2/50/63,4 cm | W/D/H 176,2/50/63,4 cm | W/D/H 176,2/50/63,4 cm | W/D/H 176,2/50/63,4 cm |
| Description | Lowboard 176/63, 4 Hatches, wide hatches left | Lowboard 176/63, 4 Hatches, wide hatches right | Lowboard 176/63, 4 Hatches, Glass hatch left | Lowboard 176/63, 4 Hatches, Glass hatch right |
| WILD OAK | | | | |
| WILD NUT | | | | |
| 2 Drawers instead of hatches at the top | | | Drawer instead of hatch at the top | |
| 2 Drawers instead of hatches at the bottom | | | | |
| Cable management - Hatch incl. plug connector | | | | |
| |  |  |  |  |
| | W/D/H 211,4/50/63,4 cm | W/D/H 211,4/50/63,4 cm | W/D/H 211,4/50/63,4 cm | W/D/H 211,4/50/63,4 cm |
| Description | Lowboard 211/63, 4 Hatches, wide hatches left | Lowboard 211/63, 4 Hatches, wide hatches right | Lowboard 211/63, 4 Hatches, Glass hatch left | Lowboard 211/63, 4 Hatches, Glass hatch right |
| WILD OAK | | | | |
| WILD NUT | | | | |
| 2 Drawers instead of hatches at the top | | | Drawer instead of hatch at the top | |
| 2 Drawers instead of hatches at the bottom | | | | |
| Cable management - Hatch incl. plug connector | | | | |
| |  |  |  | |
| | W/D/H 211,4/50/63,4 cm | W/D/H 211,4/50/63,4 cm | W/D/H 211,4/50/63,4 cm | |
| Description | Lowboard 211/63, 4 Hatches | Lowboard 211/63, 4 Hatches, Glass hatch left | Lowboard 211/63, 4 Hatches, Glass hatch right | |
| WILD OAK | | | | |
| WILD NUT | | | | |
| 2 Drawers instead of hatches at the top | | Drawer instead of hatch at the top | | |
| 2 Drawers instead of hatches at the bottom | | | | |
| Cable management - Hatch incl. plug connector | | | | |











| TV-Elemente with cable management and a pre-installed quadruple plug-connector | | | | |
|--|---|---|--|---|
| |  |  |  |  |
| | W/D/H 141/50/130,6 cm | W/D/H 141/50/130,6 cm | W/D/H 141/50/159,4 cm | W/D/H 141/50/159,4 cm |
| Description | TV-Element with wall panel 141/131, 1 Wooden hatch | TV-Element with wall panel 141/131, 1 Glass hatch | TV-Element with wall panel 141/159, 2 Wooden hatches | TV-Element with wall panel 141/159, 1 Glass-, 1 Wooden hatch |
| WILD OAK | | | | |
| WILD NUT | | | | |
| Drawer instead of hatch at the top | | | | no drawer instead of hatch possible! |
| Drawer instead of hatch at the bottom | | no drawer instead of hatch possible! | | |

Suspended elements



| Glass shelf rows maximal 5 kg resilient - Total resilience: maximal 60 kg | | | | |
|---|--|---|---|--|
| | 3 Shelf rows  | 2 fixed shelf rows, 2 fixed glass shelf rows  | left: 2 fixed shelf rows, 2 fixed glass shelf rows right: 2 Shelf rows  | left: 2 Shelf rows right: 2 fixed shelf rows, 2 fixed glass shelf rows  |
| | W/D/H 53/34/134,4 cm | W/D/H 53/34/134,4 cm | W/D/H 70,6/34/119,2 cm | W/D/H 70,6/34/119,2 cm |
| Description | Suspended element, 1 Wooden door Door stop left Door stop right | Suspended element, 1 Glass door Door stop left Door stop right | Suspended element, 2 Doors, Glass door left | Suspended element, 2 Doors, Glass door right |
| WILD OAK | | | | |
| WILD NUT | | | | |
| Lighting per switch | | | | |
| Lighting per radio + dimmer | | | | |
| Rear panel made of spruce | | | | |
| | Glass shelf rows max. 5 kg resilient, Total resilient max. 15 kg  | Total resilience: maximal 70 kg  | |  |
| | W/D/H 105,8/34/61,4 cm | W/D/H 141/45/90,1 cm | W/D/H 141/45/124,7 cm | |
| Description | Suspendit element 106/61, with shelf | TV-Suspended element with panel 141/90, Wooden hatch | TV-Suspended element with panel 141/125, Wooden hatch | |
| WILD OAK | | | | |
| WILD NUT | | | | |
| Drawer 141 instead of hatch | | | | |



| | Total resilience: maximal 50 kg | | Total resilience: maximal 70 kg | | |
|-----------------------------|---|---|---|--|---|
| |  |  |  |  |  |
| | W/D/H 105,8/45/28,7 cm | W/D/H 141/45/28,7 cm | W/D/H 211,4/45/28,7 cm | W/D/H 211,4/45/28,7 cm | W/D/H 211,4/45/28,7 cm |
| Description | Suspended element with hatch | Suspended element with hatch | Suspended element wide hatch left | Suspended element wide hatch right | Suspended element with 2 hatches |
| WILD OAK | | | | | |
| WILD NUT | | | | | |
| Drawer 106 instead of hatch | | | | | Please indicate where it shall be placed (sketch) ! |
| Drawer 141 instead of hatch | | | | | |
| Drawer 70 instead of hatch | | | | | |

Wall panels, wall shelves





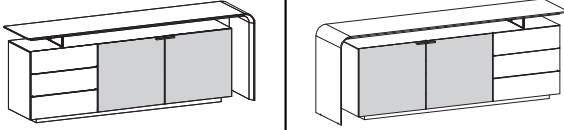
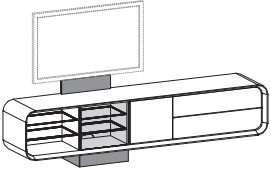
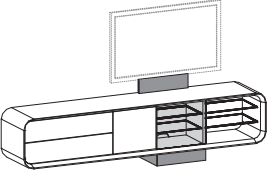

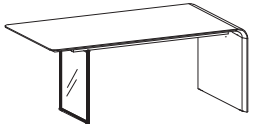
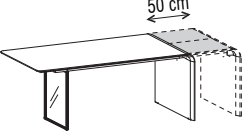
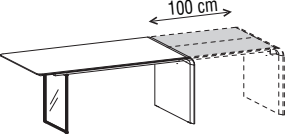

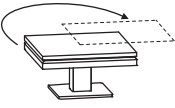
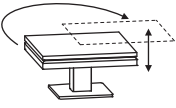
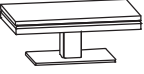
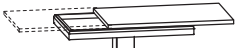
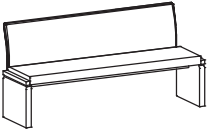
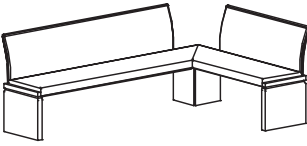
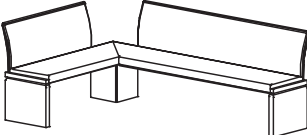





| | Glass shelf Tinted glass - maximal 10 kg resilient | | | | |
|-----------------------------|---|---|---|--|---|
| |  |  |  |  |  |
| | W/D/H 105,8/21,8/34,6 cm | W/D/H 141/21,8/34,6 cm | W/D/H 176,2/21,8/34,6 cm | W/D/H 211,4/21,8/34,6 cm | W/D/H 246,4/21,8/34,6 cm |
| Description | Wall panel 106/35 with glass shelf | Wall panel 141/35 with glass shelf | Wall panel 176/35 with glass shelf | Wall panel 211/35 with glass shelf | Wall panel 246/35 with glass shelf |
| WILD OAK | | | | | |
| WILD NUT | | | | | |
| Lighting per switch | | | | | |
| Lighting per radio + dimmer | | | | | |
| | with fittings for sturdy masonry - maximal 10 kg resilient | | | | |
| |  |  |  |  |  |
| | W/D/H 105,8/24/3,9 cm | W/D/H 141,2/24/3,9 cm | W/D/H 176/24/3,9 cm | W/D/H 211,4/24/3,9 cm | W/D/H 246,4/24/3,9 cm |
| Description | Wall shelf 106 | Wall shelf 141 | Wall shelf 176 | Wall shelf 211 | Wall shelf 246 |
| WILD OAK | | | | | |
| WILD NUT | | | | | |







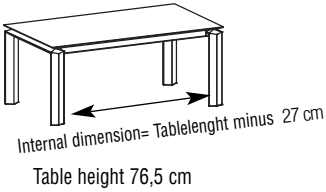
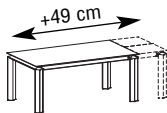
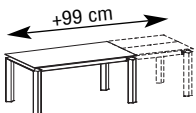

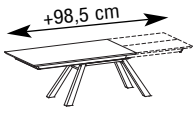

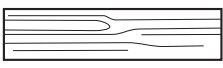
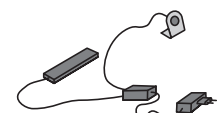
Cable ducts

| | Detachable superior cover plate, with a pre-installed quadruple plug-connector | | |
|-----------------|---|---|---|
| |  |  |  |
| | W/D/H 105,8/10,1/20,2 cm | W/D/H 141/10,1/20,2 cm | W/D/H 211,4/10,1/20,2 cm |
| Description | Cable duct 106 | Cable duct 141 | Cable duct 211 |
| WILD OAK | | | |
| WILD NUT | | | |

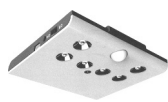
| | | | | | |
|-----------------|--|--|---|---|----------|
| | <p>Frontend colorglass optiwhite Structure plate and sidewall in all solid wood 1 shelf</p>  <p>W/D/H 220 / 50 / 79,6 cm W/D/H 220 / 50 / 79,6 cm</p> | | | | |
| Description | Sideboard 220, 2 doors, 3 drawers, with structure plate | Sideboard 220, 2 doors, 3 drawers, with structure plate, drawers right | | | |
| WILD OAK | | | | | |
| NUT | | | | | |
| | <p><u>Furnishing: from left to right:</u> 2 glass shelf rows 2 glass shelf rows behind the sliding door 1 door 2 drawers</p>  <p>W/D/H 235 / 45,5 / 71,4 cm</p> | <p><u>Furnishing: from left to right:</u> 2 drawers 1 door 2 glass shelf rows behind the sliding door 2 glass shelf rows</p>  <p>W/D/H 235 / 45,5 / 71,4 cm</p> | <p>resilience: 5kg for each glass shelf row (total 15 kg)</p>  <p>W/D/H 79,4 / 21,2 / 60 cm</p> | <p>Shelf row in glass</p>  <p>W/D/H 75 / 120 / 41,5 cm</p> | |
| Description | Multimedia element, left | Multimedia element, right | Panel shelf with 3 glass shelf rows | Coffetable 75/120 cm, with glass shelf row | |
| WILD OAK | | | | | |
| NUT | | | | | |
| | <p>Table top and wooden side wall: solid wood Glass side wall: laminated safety glass - transparent glass</p>  <p>Table height 76,5 cm</p> | | <p>Elongation satinised frosted glass optiwhite</p>   <p>length minimum 189cm</p> | | |
| Description | Table height 76,5 cm | | Elongation 50 cm | Elongation 100 cm | |
| Measures W/L | 100/169 cm | 100/189 cm | 100/209 cm | + 50 cm | + 100 cm |
| Wild oak | | | | | |
| NUT | | | | | |

| | | | | | | | | |
|--------------------|---|---------|--|---------|--|---------|---|---------|
| | <p>Coffee tables 90 / 90 cm Revolvable plate, interior lighting</p>  <p>W/D/H 90/90/46,5 cm</p> | | <p>height adjustable 47 bis 83 cm</p>  <p>W/D/H 90/90/47 cm</p> | | <p>Coffee table 75 / 120 cm</p>  <p>B/L/H 75/120/46,5 cm</p> | | <p>Accessory for FC71: le. + ri. cir. 40 cm slidable</p>  | |
| Description | Coffee table 90/90, revolvable plate | | Coffee table 90/90, revolvable plate, height adjustable | | Coffee table 75/120 | | slidable plate and interior lighting | |
| WILD OAK | | | | | | | | |
| WILD NUT | | | | | | | | |
| | <p>Seat and backrest upholstered with leather or loden Backrest with leather cord edge, suitable bordered (in case of Loden - Leather cord edge black)</p> <p>Upholstery seat: Foamed material 35 mm Density 50 Hardness 75</p>  <p>Seat height cir. 49 cm</p> | | | | | | | |
| Description | Upholstered seating bench | | Upholstered seating bench | | Upholstered seating bench | | Upholstered seating bench | |
| W/D/H | 147,8/58/89 cm | | 167,8/58/89 cm | | 187,8/58/89 cm | | 207,8/58/89 cm | |
| Seat cover | Loden | Leather | Loden | Leather | Loden | Leather | Loden | Leather |
| WILD OAK | | | | | | | | |
| WILD NUT | | | | | | | | |
| | <p>Seat and backrest upholstered with leather or loden Backrest with leather cord edge, suitable bordered (in case of Loden - Leather cord edge black)</p> <p>Upholstery seat: Foamed material 35 mm Density 50 Hardness 75</p>  <p>Upholstered corner (short side at the right)</p> | | | | | | | |
| Description | Upholstered corner (short side at the right) | | Upholstered corner (short side at the right) | | Upholstered corner (short side at the right) | | Upholstered corner (short side at the right) | |
| Side length L/R | 202/162 cm | | 222/162 cm | | 242/162 cm | | 262/162 cm | |
| Suiting table size | 100/140 cm | | 100/160 cm | | 100/180 cm | | 100/200 cm | |
| Seat cover | Loden | Leather | Loden | Leather | Loden | Leather | Loden | Leather |
| WILD OAK | | | | | | | | |
| WILD NUT | | | | | | | | |
| | <p>Seat and backrest upholstered with leather or loden Backrest with leather cord edge, suitable bordered (in case of Loden - Leather cord edge black)</p> <p>Upholstery seat: Foamed material 35 mm Density 50 Hardness 75</p>  <p>Total height cir. 89 cm, Seat height cir. 49 cm</p> | | | | | | | |
| Description | Upholstered corner (short side at the left) | | | | | | | |
| Side length L/R | 162/202 cm | | 162/222 cm | | 162/242 cm | | 162/262 cm | |
| Suiting table size | 100/140 cm | | 100/160 cm | | 100/180 cm | | 100/200 cm | |
| Seat cover | Loden | Leather | Loden | Leather | Loden | Leather | Loden | Leather |
| WILD OAK | | | | | | | | |
| WILD NUT | | | | | | | | |

| | | | | | | | | | | | | | | |
|--|---|---|---|---|--|---|---|---|---|--|-------------------------------------|---------|------------------------------|--|
| Seat height approx. 48 cm Synthetic glides on all chairs (felt glides included) | Seat and backrest with loden or leather acc. collection suitably edged with leather piping (black leather piping with loden) | | | | | | | | Seat upholstered, backrest in wood Chair stackable | Seat and backrest upholstered Back upholstered (other fabric available) | | | | |
| |  W/D/H ca. 49/54/89 cm |  W/D/H ca. 59/54/89 cm |  B/T/H ca. 62/63/83 cm |  W/D/H ca. 53/57/82 cm |  B/T/H ca. 54/61/86 cm |  W/D/H ca. 50/61/88 cm | Mention details: Fabric back Fabric seat | | | | | | | |
| Description | Upholstered chair 46 | | Upholstered chair 46, with armrests | | Upholstered chair 38, with armrests | | Upholstered chair 35 | | Stuhl 55 | | Upholstered chair 64 | | | |
| Upholstery | Loden | Leather | Loden | Leather | Loden | Leather | Loden | Leather | Loden | Leather | Loden | Leather | Leather-Loden combined | |
| WILD OAK | | | | | | | | | | | | | | |
| WILD NUT | | | | | | | | | | | | | | |
| Seat height approx. 48 cm Synthetic glides on all chairs (felt glides included) | Seat upholstered with leather, wooden backrest NOT AVAILABLE IN LODEN! | | | | Seat and backrest upholstered with leather, NOT AVAILABLE IN LODEN! | | | | | | | | | |
| |  B/T/H ca. 47/57/86 cm |  B/T/H ca. 53/57/86 cm | Back seat shell, leather  B/T/H ca. 46/54/90 cm | | Back seat shell, wood  B/T/H ca. 53/54/90 cm | |  B/T/H ca. 46/54/90 cm |  B/T/H ca. 53/54/90 cm |  B/T/H ca. 49/56/85 cm | | | | | |
| Description | Centilevered chair | | Centilevered chair, with armrests | | Centilevered chair 2 | | Centilevered chair 2, with armrests | | Centilevered chair 3 | | Centilevered chair 3, with armrests | | Upholstered chair 4 | |
| Upholstery | Leather | | Leather | | Leather | | Leather | | Leather | | Leather | | Leather | |
| WILD OAK | | | | | | | | | | | | | | |
| WILD NUT | | | | | | | | | | | | | | |
| Tabletop massiv 3,2 cm  Internal dimension = Tablelength minus 27 cm Table height 76,5 cm | | | | | | | | |  +49 cm |  +99 cm length minimum 180 cm | | | | |
| | Description | | | | | | | | | | Surcharge Elongation 49 cm | | Surcharge Elongation 99 cm | |
| W / L cm | 90/140 | 90/160 | 90/180 | 90/200 | 90/220 | 100/160 | 100/180 | 100/200 | 100/220 | + 49 cm | | + 99 cm | | |
| WILD OAK | | | | | | | | | | | | | | |
| WILD NUT | | | | | | | | | | | | | | |
| Tabletop massiv 2,6 cm  Table height 76,5 cm | | | | | | | | |  +48,5 cm |  +98,5 cm length minimum 180 cm | | | | |
| | Description | | | | | | | | | | Surcharge Elongation 48,5 cm | | Surcharge Elongation 98,5 cm | |
| W / L cm | 100/140 | | 100/160 | | 100/180 | | 100/200 | | | | + 48,5 cm | | + 98,5 cm | |
| WILD OAK | | | | | | | | | | | | | | |
| WILD NUT | | | | | | | | | | | | | | |

| | | | | |
|----------------------------|--|---|---|--|
| | <p>(core plywood veneered, edged around) max. Length 252 cm max. Width 110 cm Thickness boards: 14, 20, oder 23 mm</p>  <p>price per m2 (calculated min. 0,5 m2))</p> | <p>Conducts signals of customary remote control through closed furniture front. The TV-equipment shouldn't be separat by carcasse sides - have to be well-positioned in one corpus</p>  | <p>in tinted glass, max 40 kg resilient</p> | |
| | | |  <p>W/D/H 92/32/13 cm</p> |  <p>W/D/H 130,9/32/13 cm</p> |
| Description | Cover plate double sided veneered | Infrarot-Repeater | TV-frame in glass 92 cm | TV-frame in glass 131 cm |
| WILD OAK | | | | |
| WILD NUT | | | | |
| WOOD MAINTENANCE | | | | |
| | <p>250 ml Voglauer Maintenance oil and polishing cloth</p>  <p>The original Voglauer wood maintenance oil cleans and refreshes the surfaces and at the same time creates a breathable protective film.</p> | <p>Repair set comprises: 100 ml Voglauer cleanser 100 ml Surface oil Scotch-Bride and polishing cloths</p>  <p>In order to fix little surface damages and impureness.</p> <p>Indicate Type of wood!</p> | <ul style="list-style-type: none"> - Motion sensor - 6x LED, 0,5 Watt - with charging cable - in case of USB rechargeable - no cabling essential  <p>B/T/H ca. 10/8,5/1 cm</p> | <p>Mains plug with USB-connector for loading of the Battery_LED-light (Standard USB-Charger 5V/DC, 1 Ampere, 100-240V)</p>  <p>B/T/H ca. 4/6,5/1,7 cm</p> |
| Description | Maintenance set for oiled surfaces | Repair set for oiled surfaces | Battery LED-light | USB-Recharger |
| PRICE | | | | |
| LEATHER MAINTENANCE | | | | |
| | <p>200 ml soft cleaner 200 ml maintenance cream with light protection Sponge and cloths</p>  <p>The original Voglauer leather maintenance set for thorough and yet gentle cleaning as well as impregnation of leather. Recommended: 2 - 4 applications per year.</p> | <p>Contents 200 ml</p>  <p>To remove strong, not fatty pollution and dust deposit on the leather.</p> | <p>Contents 200 ml</p>  <p>Highly effective impregnation and light protection. The dubbin gets refreshed and the leather stays soft and sleek, retarding the fading of the color.</p> | <p>Contents 200 ml</p>  <p>To refresh faded and galled leather. Recommended: Impregnation with maintenance cream afterwards</p> <p>Indicate Color of leather!</p> |
| Description | Leather maintenance set | Leather intensive cleaner | Leather maintenance cream | Leather color lotion |
| PRICE | | | | |

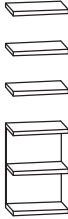
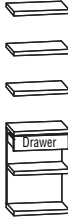
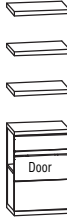
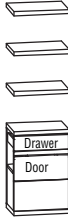
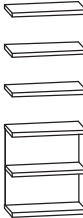
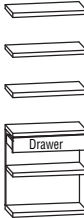
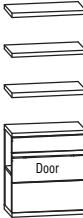
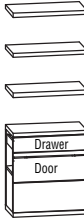
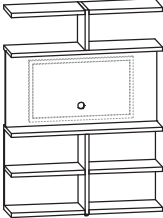
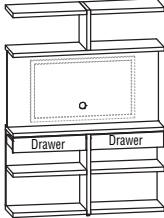
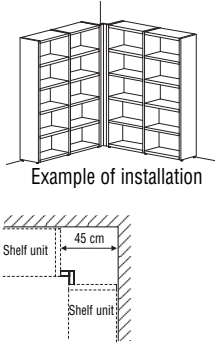
| | | | | | |
|-----------------|---|---|--|--|---|
| |  |  |  |  |  |
| | W/D/H 3,9/38,5/198,1 cm | W/D/H 52,8/38,5/198,1 cm | W/D/H 52,8/38,5/198,1 cm | W/D/H 52,8/38,5/198,1 cm | W/D/H 52,8/38,5/198,1 cm |
| Description | Side wall Height 5 | Breaker-shelf unit 53, Height 5 | Breaker-shelf unit 53, Height 5 with drawer | Breaker-shelf unit, Height 5, with door Door stop left Door stop right | Breaker-shelf unit, Height 5, with do.+dr. Door stop left Door stop right |
| WILD OAK | | | | | |
| WILD NUT | | | | | |
| |  |  |  |  | |
| | W/D/H 70,4/38,5/198,1 cm | W/D/H 70,4/38,5/198,1 cm | W/D/H 70,4/38,5/198,1 cm | W/D/H 70,4/38,5/198,1 cm | |
| Description | Breaker-shelf unit 70, Height 5 | Breaker-shelf unit 70, Height 5 with drawer | Breaker-shelf unit, Height 5, with do.+dr. Door stop left Door stop right | Breaker-shelf unit, Height 5, with do.+dr. Door stop left Door stop right | |
| WILD OAK | | | | | |
| WILD NUT | | | | | |
| |  |  |  | | |
| | W/D/H 144,7/38,5/198,1 cm | W/D/H 144,7/38,5/198,1 cm | W/D/H 10,9/10,9/198,1 cm | | |
| Description | TV-Breaker-element 145, Height 5 | TV-Breaker-element 145, Height 5, with 2 drawers | Corner joint cover, Height 5 | | |
| WILD OAK | | | | | |
| WILD NUT | | | | | |

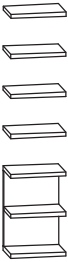
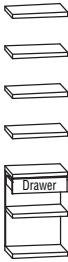
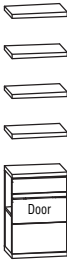
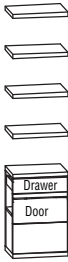
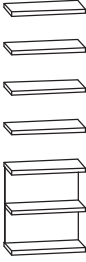
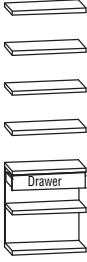
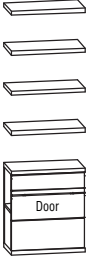
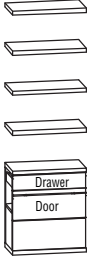
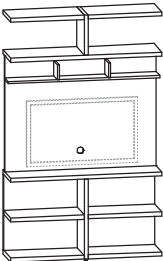
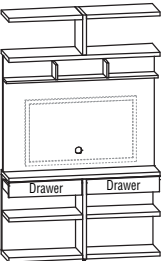
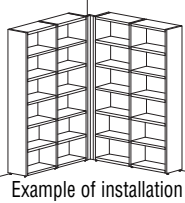
| | | | | | |
|-----------------|---|---|--|--|---|
| |  |  |  |  |  |
| | W/D/H 3,9/38,5/236,5 cm | W/D/H 52,8/38,5/236,5 cm | W/D/H 52,8/38,5/236,5 cm | W/D/H 52,8/38,5/236,5 cm | W/D/H 52,8/38,5/236,5 cm |
| Description | Side wall Height 6 | Breaker-shelf unit 53, Height 6 | Breaker-shelf unit 53, Height 6, with drawer | Breaker-shelf unit, Height 6, with Door Door stop left Door stop right | Breaker-shelf unit, Height 6, with do.+dr Door stop left Door stop right |
| WILD OAK | | | | | |
| WILD NUT | | | | | |
| |  |  |  |  | |
| | W/D/H 70,4/38,5/236,5 cm | W/D/H 70,4/38,5/236,5 cm | W/D/H 70,4/38,5/236,5 cm | W/D/H 70,4/38,5/236,5 cm | |
| Description | Breaker-shelf unit 70, Height 6 | Breaker-shelf unit 70, Height 6, with drawer | Breaker-shelf unit, Height 6, with door Door stop left Door stop right | Breaker-shelf unit, Height 6, with do.+Dr. Door stop left Door stop right | |
| WILD OAK | | | | | |
| WILD NUT | | | | | |
| |  |  |  | | |
| | W/D/H 144,7/38,5/236,5 cm | W/D/H 144,7/38,5/236,5 cm | W/D/H 10,9/10,9/236,5 cm | | |
| Description | TV-Breaker-element 145, Height 6 | TV-Breaker-element 145, Height 6, with 2 drawers | Corner joint cover, Height 6 | | |
| WILD OAK | | | | | |
| WILD NUT | | | | | |

Glass sliding front only for shelf units 70 - suiting slide rails must be ordered separately!

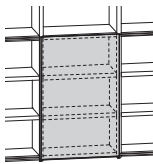
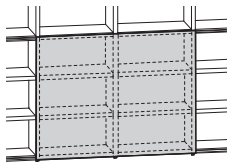
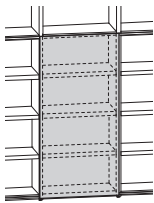
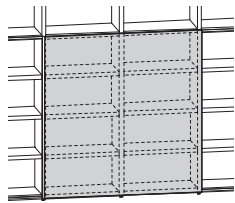
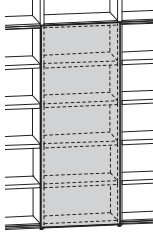
| | | | | | | | | |
|-------------|---|---|---|---|---|-----------------------------------|----------------------------------|-----------|
| |  |  |  |  |  | | | |
| | B/H 76,2/117,5 cm | B/H 152,5/117,5 cm | B/H 76,2/155,9 cm | B/H 152,5/155,9 cm | B/H 76,2/194,3 cm | | | |
| Description | Glass sliding front 76, Height 3 | | Glass sliding front 152, Height 3 | | Glass sliding front 76, Height 4 | Glass sliding front 152, Height 4 | Glass sliding front 76, Height 5 | |
| Glass | grandbrown | optiwhite | grandbrown | optiwhite | grandbrown | optiwhite | grandbrown | optiwhite |
| PRICE | | | | | | | | |

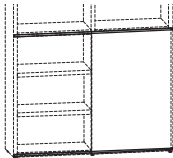
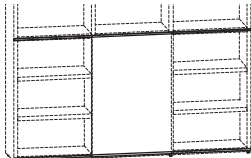
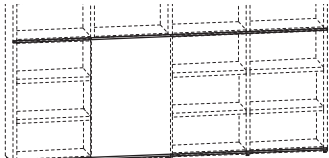
| | | | | |
|-------------|---|--|---|-------------------------------------|
| |  |  |  | |
| | Length 2 x 152,3 cm | Length 2 x 226,6 cm | Length 2 x 300,9 cm | |
| Description | Pair of rails for 2 x Shelf unit 70 | | Pair of rails for 3 x Shelf unit 70 | Pair of rails for 4 x Shelf unit 70 |
| PRICE | | | | |

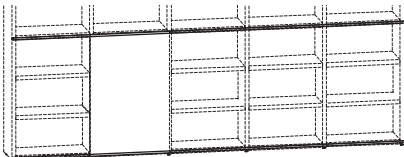
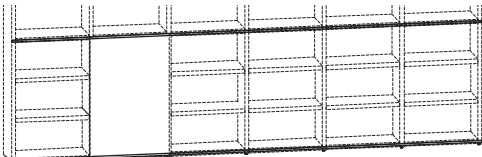
| | | |
|-------------|---|--|
| |  |  |
| | Length 2 x 375,2 cm | Length 2 x 449,5 cm |
| Description | Pair of rails for 5 x Shelf unit 70 | Pair of rails for 6 x Shelf unit 70 |
| PRICE | | |

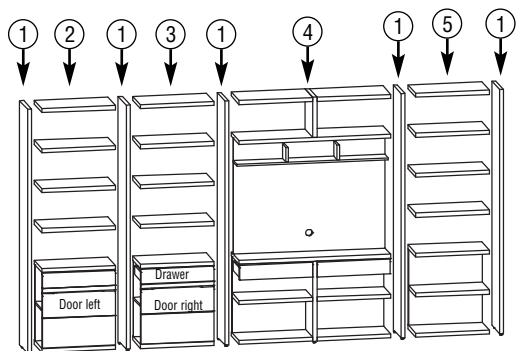

Worked sample: Planning shelf unit

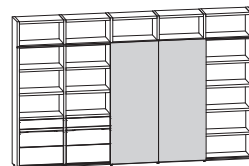

- ① 5x Side wall Height 6
- ② 1x Breaker-shelf unit 70, Height 6 with door, door stop left
- ③ 1x Breaker-shelf unit 70, Height 6 with doo.+dra, door stop right
- ④ 1x TV-Breaker-element 145, Height 6 with 2 drawers
- ⑤ 1x Breaker-shelf unit 70, Height 6
- ⑥ 2x Glass sliding front 76, Height 5, grandbrown
- ⑦ 1x Pair of rails for 5 x Shelf unit 70

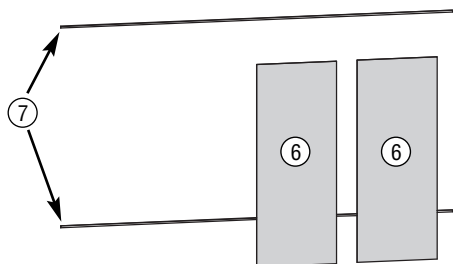

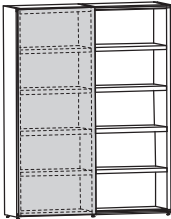
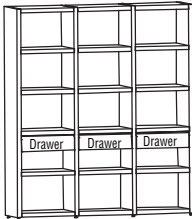
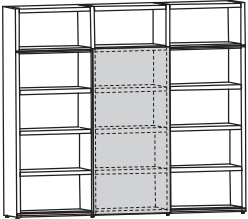
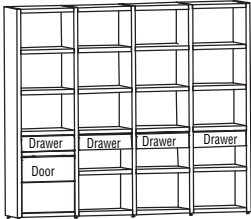
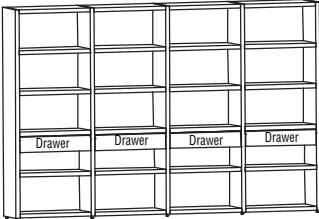
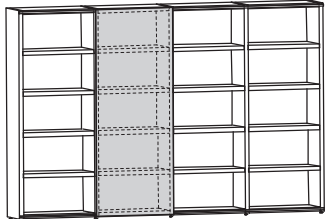
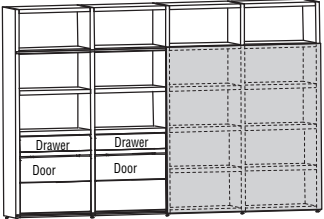
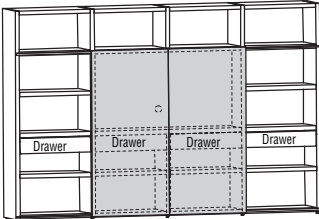
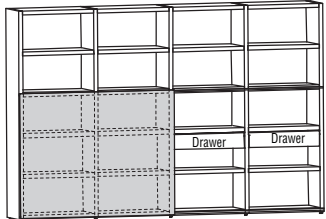
| | | | | | | |
|-----------------|--|------------|---|-----------|---|------------|
| | <p>Suggestion comprises:</p> <p>3x Side wall Height 5 2x Breaker-shelf unit 70, Height 5 1x Glass sliding front 76/194, Height 5 1x Pair of rails for 2 x Shelf unit 70</p>  <p>W/D/H 152,5/41/198,1cm</p> | | <p>Suggestion comprises:</p> <p>4x Side wall Height 5 3x Breaker-shelf unit 53, Height 5 with drawer</p>  <p>W/D/H 174/38,5/198,1cm</p> | | <p>Suggestion comprises:</p> <p>4x Side wall Height 5 3x Breaker-shelf unit 70, Height 5 1x Glass sliding front 76/156, Height 4 1x Pair of rails for 3 x Shelf unit 70</p>  <p>W/D/H 226,8/41/198,1cm</p> | |
| Description | Shelf unit suggestion 511 | | Shelf unit suggestion 518 | | Shelf unit suggestion 525 | |
| Glass front | grandbrown | optiwhite | - | | grandbrown | optiwhite |
| Left - Right | comme im. | rev. image | - | | - | - |
| WILD OAK | | | | | | |
| WILD NUT | | | | | | |
| | <p>Suggestion comprises:</p> <p>5x Side wall Height 5 1x Breaker-shelf unit, 53, Height 5 m. Door,left 3x Breaker-shelf unit 53, Height 5 with drawer</p>  <p>W/D/H 230,7/38,5/198,1cm</p> | | <p>Suggestion comprises:</p> <p>5x Side wall Height 5 4x Breaker-shelf unit 70, Height 5 with drawer</p>  <p>W/D/H 301,1/38,5/198,1cm</p> | | <p>Suggestion comprises:</p> <p>5x Side wall Height 5 4x Breaker-shelf unit 70, Height 5 1x Glass sliding front 76/194, Height 5 1x Pair of rails for 4 x Shelf unit 70</p>  <p>W/D/H 301,1/41/198,1cm</p> | |
| Description | Shelf unit suggestion 532 | | Shelf unit suggestion 539 | | Shelf unit suggestion 546 | |
| Glass front | - | | - | | grandbrown | optiwhite |
| Left - Right | comme im. | rev. image | - | | comme im. | rev. image |
| WILD OAK | | | | | | |
| WILD NUT | | | | | | |
| | <p>Suggestion comprises:</p> <p>5x Side wall Height 5 2x Breaker-shelf unit 70, Height 5, m. 2x Door+Drawer, li.+re. 1x Breaker-shelf unit 70, Height 5 1x Glass sliding front 152/156, Height 4 1x Pair of rails for 4 x Shelf unit 70</p>  <p>W/D/H 301,1/41/198,1cm</p> | | <p>Suggestion comprises:</p> <p>4x Side wall Height 5 2x Breaker-shelf unit 70, Height 5 with drawer 1x TV-Element 145, Height 5 with 2 drawers 2x Glass sliding front 76/156, Height 4 1x Pair of rails for 4 x Shelf unit 70</p>  <p>W/D/H 301,1/41/198,1cm</p> | | <p>Suggestion comprises:</p> <p>5x Side wall Height 5 2x Breaker-shelf unit 70, Height 5 2x Breaker-shelf unit 70, Height 5 with drawer 1x Glass sliding front 152/117, Height 3 1x Pair of rails for 4 x Shelf unit 70</p>  <p>W/D/H 301,1/41/198,1cm</p> | |
| Description | Shelf unit suggestion 553 | | Shelf unit suggestion 560 | | Shelf unit suggestion 567 | |
| Glass front | grandbrown | optiwhite | grandbrown | optiwhite | grandbrown | optiwhite |
| Left - Right | comme im. | rev. image | - | | comme im. | rev. image |
| WILD OAK | | | | | | |
| WILD NUT | | | | | | |

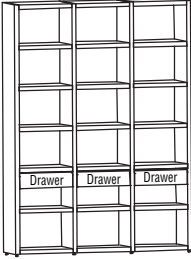
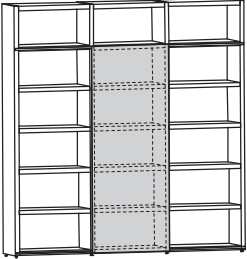
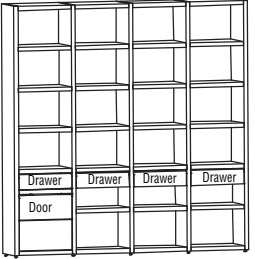
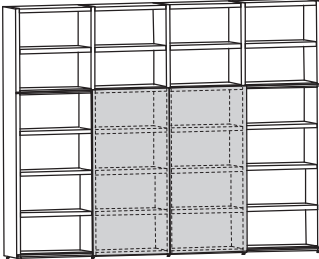
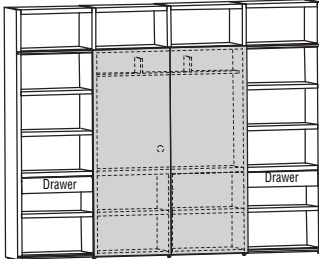
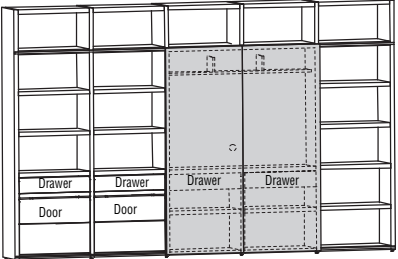
| | | | | | | |
|-----------------|--|---|--|-----------|---------------------------|------------|
| | <p>Suggestion comprises:</p> <p>4x Side wall Height 6 3x Breaker-shelf unit 53, Height 6 with drawer</p>  <p>W/D/H 174/38,5/236,5cm</p> | <p>Suggestion comprises:</p> <p>4x Side wall Height 6 3x Breaker-shelf unit 70, Height 6 1x Glass sliding front76/194, Height 5 1x Pair of rails for 3 x Shelf unit 70</p>  <p>W/D/H 226,8/41/236,5cm</p> | <p>Suggestion comprises:</p> <p>5x Side wall Height 6 1x Breaker-shelf unit 53, Height 6 with Door 3x Breaker-shelf unit 53, Height 6 with drawer</p>  <p>W/D/H 230,7/38,5/236,5cm</p> | | | |
| Description | Shelf unit suggestion 612 | | Shelf unit suggestion 619 | | Shelf unit suggestion 626 | |
| Glass front | - | | grandbrown | optiwhite | - | |
| Left - Right | | | | | such as ill. | rev. image |
| WILD OAK | | | | | | |
| WILD NUT | | | | | | |
| | <p>Suggestion comprises:</p> <p>5x Side wall Height 6 4x Breaker-shelf unit 70, Height 6 2x Glass sliding front76/156, Height 4 1x Pair of rails for 4 x Shelf unit 70</p>  <p>W/D/H 301,1/41/236,5cm</p> | <p>Suggestion comprises:</p> <p>4x Side wall Height 6 2x Breaker-shelf unit 70, Height 6 with drawer 1x TV-Element 145, Height 6 2x Glass sliding front76/194, Height 5 1x Pair of rails for 4 x Shelf unit 70</p>  <p>W/D/H 301,1/41/236,5cm</p> | <p>Suggestion comprises:</p> <p>5x Side wall Height 6 1x Breaker-shelf unit 70, Height 6 w. Door, li. 1x Breaker-shelf unit 70, Height 6 w. Do.+Dra. 1x TV-Element 145, Height 6 with 2 drawers 1x Breaker-shelf unit 70, Height 6 2x Glass sliding front76/194, Height 5 1x Pair of rails for 5 x Shelf unit 70</p>  <p>W/D/H 375,4/41/236,5cm</p> | | | |
| Description | Shelf unit suggestion 633 | | Shelf unit suggestion 640 | | Shelf unit suggestion 647 | |
| Glass front | grandbrown | optiwhite | grandbrown | optiwhite | grandbrown | optiwhite |
| Left - Right | - | - | - | - | such as ill. | rev. image |
| WILD OAK | | | | | | |
| WILD NUT | | | | | | |

- Suggestion comprises:
- 6x Side wall Height 6
 - 3x Breaker-shelf unit 70, Height 6 with drawer
 - 2x Breaker-shelf unit 70, Height 6
 - 2x Glass sliding front 76/194, Height 5
 - 1x Pair of rails for 5 x Shelf unit 70

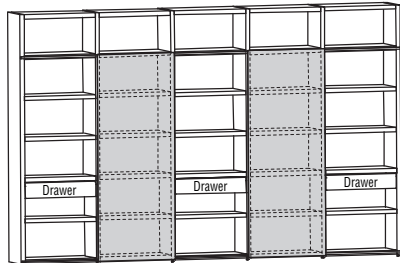

W/D/H 375,4/41/236,5cm

- Suggestion comprises:
- 6x Side wall Height 6
 - 1x Breaker-shelf unit 70, Height 6 with door, left
 - 2x Breaker-shelf unit 70, Height 6 with drawer
 - 2x Breaker-shelf unit 70, Height 6
 - 1x Glass sliding front 152/156, Height 4
 - 1x Pair of rails for 5 x Shelf unit 70

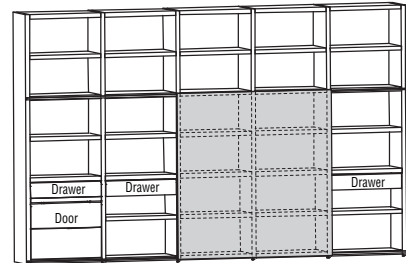

W/D/H 375,4/41/236,5cm

| | | | | |
|-----------------|---------------------------|-----------|---------------------------|-------------------------|
| Description | Shelf unit suggestion 654 | | Shelf unit suggestion 661 | |
| Glass front | grandbrown | optiwhite | grandbrown | optiwhite |
| Left - Right | - | - | such as ill. rev. image | such as ill. rev. image |
| WILD OAK | | | | |
| WILD NUT | | | | |

- Suggestion comprises:
- 7x Side wall Height 6
 - 6x Breaker-shelf unit 70, Height 6
 - 1x Pair of rails for 6 x Shelf unit 70
 - 1x Glass sliding front 152/156, Height 4

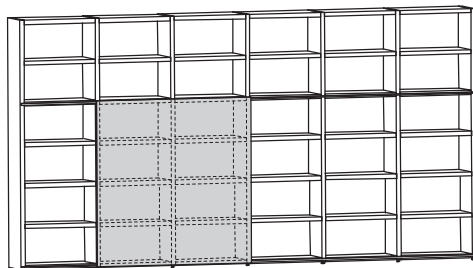

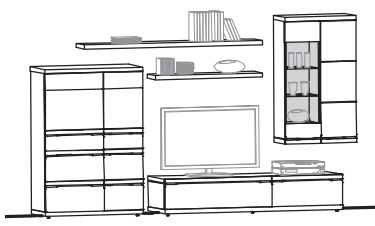

W/D/H 449,7/41/236,5cm

| | | | | |
|-----------------|---------------------------|------------|--------------|------------|
| Description | Shelf unit suggestion 668 | | | |
| Glass front | grandbrown | | optiwhite | |
| Left-Right | such as ill. | rev. image | such as ill. | rev. image |
| WILD OAK | | | | |
| WILD NUT | | | | |

| | | | |
|--|---|--|----------------|
| <p>Suggestion 130 W/D/H ca. 311 / 50 / 183 cm</p>  <p>(Suggestions always without extra charge articles)</p> | | such as ill. | reversed image |
| | | | |
| | WILD OAK | | |
| | WILD NUT | | |
| | Lighting per switch | | |
| | Lighting per radio + dimmer | | |
| | Rear panel made of spruce | | |
| | Drawer 70 instead of hatch | | |
| | Drawer 106 instead of hatch | | |
| | Cable management-Hatch incl. plug connector | | |
| | Suggestion (ill.) comprises: | | |
| | 1x | Lowboard 176/35, 2 Hatches, wide hatch left | |
| | 1x | Highboard 97, 2 Wooden doors , wide door left | |
| | 1x | Suspended element 70/119, 2 doors, Glass door left | |
| 1x | Wall shelf 106 | | |
| 1x | Wall shelf 176 | | |

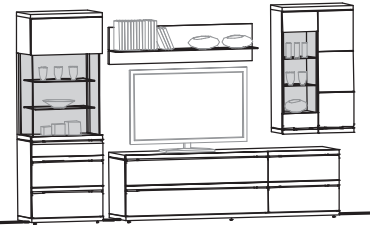
| | | | |
|--|-------------------------------|--|----------------|
| <p>Suggestion 137 W/D/H ca. 317 / 50 / 180 cm</p>  <p>(Suggestions always without extra charge articles)</p> | | such as ill. | reversed image |
| | | | |
| | WILD OAK | | |
| | WILD NUT | | |
| | Lighting per switch | | |
| | Lighting per radio + dimmer | | |
| | Rear panel made of spruce | | |
| | Drawer 70 instead of hatch* | | |
| | Drawer 141 instead of hatch | | |
| | Cable management for Lowboard | | |
| | Suggestion (ill.) comprises: | | |
| | 1x | Lowboard 211/35, 2 Hatches, wide hatch right | |
| | 1x | Suspended element 211/29, wide hatch left | |
| | 1x | Suspended element 70/119, 2 doors, Glass door left | |

| | | | |
|--|---|--|----------------|
| <p>Suggestion 165 W/D/H ca. 322 / 50 / 197,8 cm</p>  <p>(Suggestions always without extra charge articles)</p> | | such as ill. | reversed image |
| | | | |
| | WILD OAK | | |
| | WILD NUT | | |
| | Lighting per switch | | |
| | Lighting per radio + dimmer | | |
| | Rear panel made of spruce | | |
| | 2 Drawers instead of hatches at the top | | |
| | 2 Drawers instead of hatches at the bott. | | |
| | Cable management-Hatch incl. plug connector | | |
| | Suggestion (ill.) comprises: | | |
| | 1x | Lowboard 211/63, 4 Hatches, wide hatches left | |
| | 1x | Vitrine 70, 1 doors, Door stop left | |
| | 1x | Suspended element 70/119, 2 doors, Glass door left | |
| 1x | Wall panel 141/35 with glass shelf | | |

| | | | |
|--|-------------------------------|--|----------------|
| <p>Suggestion 179 W/D/H ca. 335 / 50 / 180 cm</p>  <p>(Suggestions always without extra charge articles)</p> | | such as ill. | reversed image |
| | | | |
| | WILD OAK | | |
| | WILD NUT | | |
| | Lighting per switch | | |
| | Lighting per radio + dimmer | | |
| | Rear panel made of spruce | | |
| | Drawer 106 instead of hatch | | |
| | Cable management for Lowboard | | |
| | Suggestion (ill.) comprises: | | |
| | 1x | Lowboard 211/35, 2 Hatches | |
| | 1x | Suspended element 211/29 with 2 Hatches | |
| | 1x | Suspended element 70/119, 2 doors, Glass door left | |

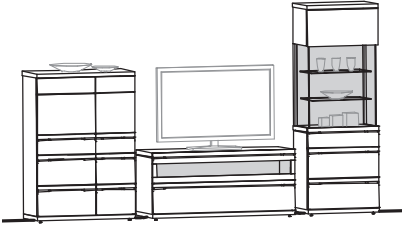
| | | | |
|--|--|--------------|----------------|
| <p>Suggestion 186 W/D/H ca. 338 / 50 / 197,8 cm</p>  <p>(Suggestions always without extra charge articles)</p> | | such as ill. | reversed image |
| | | | |
| | WILD OAK | | |
| | WILD NUT | | |
| | Lighting per switch | | |
| | Lighting per radio + dimmer | | |
| | Rear panel made of spruce | | |
| | Drawer 141 instead of hatch | | |
| | Cable management-Hatch incl. plug connector | | |
| | Suggestion (ill.) comprises: | | |
| 1x | Lowboard 141/63, 1 Wooden-, 1 Glass hatch | | |
| 1x | Highboard 97, 2 Wooden doors, wide door left | | |
| 1x | Glass cabinet 70, 1 doors, Door stop right | | |

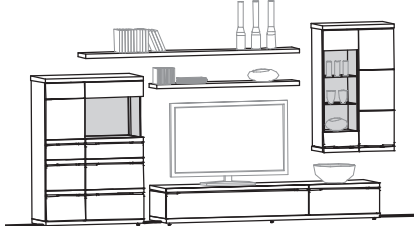
| | | | |
|---|--|--------------|----------------|
| <p>Suggestion 193 W/D/H ca. 348 / 50 / 183 cm</p>  <p>(Suggestions always without extra charge articles)</p> | | such as ill. | reversed image |
| | | | |
| | WILD OAK | | |
| | WILD NUT | | |
| | Lighting per switch | | |
| | Lighting per radio + dimmer | | |
| | Rear panel made of spruce | | |
| | Drawer 70 instead of hatch | | |
| | Drawer 141 instead of hatch | | |
| | Cable management-Hatch incl. plug connector | | |
| Suggestion (ill.) comprises: | | | |
| 1x | Lowboard 211/35, 2 Hatches, wide hatch left | | |
| 1x | Highboard 97, 2 doors, Glass right | | |
| 1x | Suspended element 70/119, 2 doors, Glass door left | | |
| 1x | Wall shelf 141 | | |
| 1x | Wall shelf 211 | | |

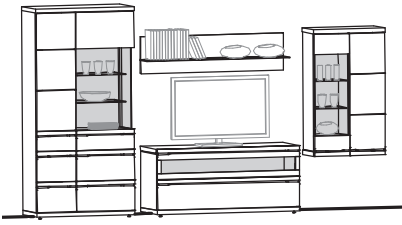
| | | | |
|--|--|--------------|----------------|
| <p>Suggestion 200 W/D/H ca. 348 / 50 / 197,8 cm</p>  <p>(Suggestions always without extra charge articles)</p> | | such as ill. | reversed image |
| | | | |
| | WILD OAK | | |
| | WILD NUT | | |
| | Lighting per switch | | |
| | Lighting per radio + dimmer | | |
| | Rear panel made of spruce | | |
| | Drawer 141 instead of hatch | | |
| | Cable management-Hatch incl. plug connector | | |
| | Suggestion (ill.) comprises: | | |
| 1x | Lowboard 141/63, 1 Wooden-, 1 Glass hatch | | |
| 1x | Vitrine 97, 2 Doors, Glass right | | |
| 1x | Suspended element 70/119, 2 doors, Glass door left | | |
| 1x | Wall panel 141/35 with glass shelf | | |

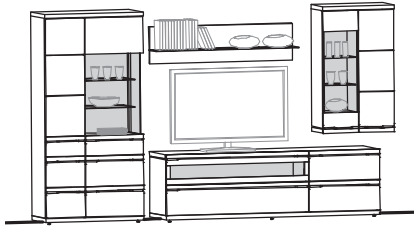
| | | | |
|--|--|--------------|----------------|
| <p>Suggestion 207 W/D/H ca. 348 / 50 / 198,7 cm</p>  <p>(Suggestions always without extra charge articles)</p> | | such as ill. | reversed image |
| | | | |
| | WILD OAK | | |
| | WILD NUT | | |
| | Lighting per switch | | |
| | Lighting per radio + dimmer | | |
| | Rear panel made of spruce | | |
| | Drawer 70 instead of hatch at the top | | |
| | 2 Drawers instead of hatches at the bot. | | |
| | Cable management-Hatch incl. plug connector | | |
| Suggestion (ill.) comprises: | | | |
| 1x | Lowboard 211/63, 4 Hatches, Glass hatch left | | |
| 1x | Vitrine 97, 2 Doors, Glass right | | |
| 1x | Suspended element 70/119, 2 doors, Glass door left | | |
| 1x | Wall panel 141/35 with glass shelf | | |

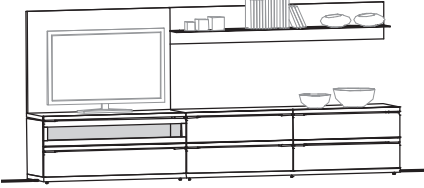
| | | | |
|--|---|--------------|----------------|
| <p>Suggestion 214 W/D/H ca. 352,4 / 50 / 159,4 cm</p>  <p>(Suggestions always without extra charge articles)</p> | | such as ill. | reversed image |
| | | | |
| | WILD OAK | | |
| | WILD NUT | | |
| | Lighting per switch | | |
| | Lighting per radio + dimmer | | |
| | 2 Drawers instead of hatches at the top | | |
| | 2 Drawers instead of hatches at the bottom | | |
| | Drawer 141 instead of hatch | | |
| | Cable management-Hatch incl. plug connector | | |
| | <p>Suggestion (ill.) comprises:</p> <ul style="list-style-type: none"> 1x Lowboard 211/63, 4 Hatches 1x TV-Element with wall panel 141/159, 1 Glass-, 1 Wooden hatch 1x Wall panel 211/35 with glass shelf | | |

| | | | |
|---|--|--------------|----------------|
| <p>Suggestion 235 W/D/H ca. 352,4 / 50 / 217 cm</p>  <p>(Suggestions always without extra charge articles)</p> | | such as ill. | reversed image |
| | | | |
| | WILD OAK | | |
| | WILD NUT | | |
| | Lighting per switch | | |
| | Lighting per radio + dimmer | | |
| | 2 Drawers instead of hatches at the top | | |
| | 2 Drawers instead of hatches at the bottom | | |
| | Drawer 141 instead of hatch | | |
| | Cable management-Hatch incl. plug connector | | |
| | <p>Suggestion (ill.) comprises:</p> <ul style="list-style-type: none"> 1x Lowboard 211/63, 4 Hatches 1x Lowboard 141/63, 1 Wooden-, 1 Glass hatch 1x Suspended element 53/134, 1 Wooden door, door stop left 1x Suspended element 53/134, 1 Glass door, door stop left | | |

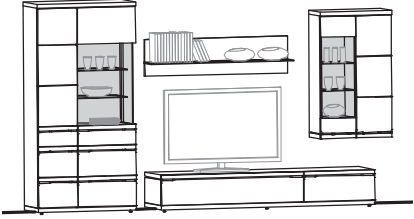
| | | | |
|--|--|--------------|----------------|
| <p>Suggestion 242 W/D/H ca. 353 / 50 / 197,8 cm</p>  <p>(Suggestions always without extra charge articles)</p> | | such as ill. | reversed image |
| | | | |
| | WILD OAK | | |
| | WILD NUT | | |
| | Lighting per switch | | |
| | Lighting per radio + dimmer | | |
| | Rear panel made of spruce | | |
| | Drawer 70 instead of hatch | | |
| | Drawer 141 instead of hatch | | |
| | Cable management-Hatch incl. plug connector | | |
| | <p>Suggestion (ill.) comprises:</p> <ul style="list-style-type: none"> 1x Lowboard 211/35, 2 Hatches, wide hatch left 1x Vitrine 97, 2 doors, Glas right 1x Suspended element 70/119, 2 doors, Glass door left 1x Wall panel 141/35 with glass shelf | | |

SALES AND SHIPMENT TERMS AND CONDITIONS

1. General

1.1. The terms and conditions of sale and shipment as detailed below are valid for all business relationships (such as purchasing agreements, contracts of work and labour, fitting agreements, etc.) between VOGLAUER MOBELWERK Gschwandtner & Zwilling GmbH & Co KG, hereinafter referred to as VOGLAUER, and its customers. Customers accept these terms as binding upon them by placing an order or closing a contract with VOGLAUER. Deviating, conflicting or amending General Terms, whether known to VOGLAUER or not, cannot become part of any contract with VOGLAUER except by express written acceptance. Inasmuch as conditions deviating from these terms and conditions of sale and shipment are agreed to in writing as part of a contract, the stipulations of the contract have priority.

1.2. VOGLAUER closes contracts strictly only with registered companies. Should in exceptional cases a customer be a consumer in the sense of consumer protection laws, such customers have the obligation to notify VOGLAUER of that fact. Otherwise, such customers will be held liable. These terms and conditions of sale and shipment will be valid for business with consumers only as far as they are in compliance with imperative stipulations of consumer protection laws.

2. Proposal, Prices

2.1. All prices quoted by VOGLAUER in proposals and price lists are non-binding and net prices except if and where it is clearly indicated that VAT is included. Prices quoted by VOGLAUER are free buyer's address, fitting excluded. VAT will be calculated separately on the basis of the legal provisions valid on the day of delivery or performance of services. VOGLAUER reserves the right to perform technical and other changes within reason. Purchase orders without prices will be processed using the applicable list prices valid the day of arrival of the order.

2.2. If goods or services are delivered later than the agreed date for reasons other than late delivery culpably caused by VOGLAUER, VOGLAUER has the right to raise the prices accordingly. Such price correction will take into account changes of labour costs according to collective treaties and actual costs for performance such as costs of material, energy, transport, financing of external services, etc. between agreed and actual delivery dates.

2.3. Export deliveries will always be charged and payable in Euros. In cases where payment is expressly agreed in a different currency, invoicing will be on the basis of the exchange rate valid on the date of order acknowledgement by VOGLAUER. For this calculation, only exchange rates calculated by Austrian banks will be relevant.

3. Order Acceptance, Subject Matter of Orders

3.1. Purchase orders issued to VOGLAUER will result in a contractual relationship only by written order acknowledgement or delivery of goods or of an invoice by VOGLAUER. Customers have the obligation to provide comprehensive and correct documentation required for the production of the goods (measurements, blueprints, etc.) with the purchase order. Additional costs possibly inflicted by deviation of the actual situation from the documents or blueprints provided by customers as well as additional costs resulting from late provision of such documents will be carried by the customer. Changes to accepted orders will only be possible by written consent.

3.2. If at the time of order placement the ordered goods are not fully specified in all detail (especially technically), a preliminary order acknowledgement will be issued. Customers have the obligation to deliver further detail (actual measurements, etc.) in such time as to allow delivery on time. Upon delivery of the details, a final order acknowledgement will be issued which determines the subject matter of the contract in a binding fashion unless customers send their dissent in writing immediately. If so, the delivery contract will remain valid as by the preliminary order acknowledgement. In case of changes to an order communicated after a preliminary order acknowledgement has been issued, the prices will be adapted to a possibly precursory estimate.

4. Shipment, Delivery

4.1. Unless agreed otherwise, delivery will be free customer's address. Transport insurance will be closed only if expressly requested by the customer. Costs arising from this will be carried by the customer. Unless agreed otherwise in writing, peril of price will be transferred to the customer at the time of shipment of the goods, or in case of late acceptance by the customer, at the time of readiness for shipment by VOGLAUER.

4.2. Unless agreed otherwise in writing, the choice of the place of shipment and the way and means of transport is in VOGLAUER's best discretion, without acceptance of any liability for cheapest or fastest transport. Delivery dates will in any event be non-binding unless expressly agreed to the contrary.

4.3. As a matter of principle, the agreed delivery periods are counted from the date of order acknowledgement. If VOGLAUER is at that time (start of lead time) not in possession of the documentation required for production such as especially actual room measurements, lead time starts at the date of receipt by VOGLAUER of the last document required. Customers have the obligation to provide such documentation in a timely manner. Delivery dates (lead times) will be extended by fitting delays not caused by VOGLAUER. In case a down payment is to be made by the customer, the lead-time will not be counted before the day of its receipt by VOGLAUER.

4.4. If acceptance of the delivered goods by the customer is delayed, whether culpably or otherwise, VOGLAUER has the right to ask a storage charge to an amount customary in the place; Furthermore, VOGLAUER has the right to withdraw from the delivery contract, upon which the customer has to pay the difference between the agreed price and the expectable revenue from realisation of the deliverable goods. In case of included fitting, customers have the obligation to accept the contractual items immediately after completion in a visit. If acceptance is denied, the purchased goods are deemed accepted.

4.5. In case that VOGLAUER fails to meet delivery dates by more than 3 weeks, customers have the right to withdraw from the contract after a reasonable period of grace. If such delay is due to operational reasons VOGLAUER cannot prevent with due diligence of a scrupulous merchant (especially strike, disruption, raw material shortage, etc.), customers will be entitled to withdraw from the contract after a two-month delay after a reasonable period of grace.

5. Withdrawal from Contract

5.1. If a customer fails to fulfil contractual obligations in full or in part, VOGLAUER has the right to withdraw from the contract. The right to withdraw from the contract can be declared for only part(s) of the goods to be delivered. In such cases, VOGLAUER has the obligation to deliver the part of the shipment which is not affected by the withdrawal and customer has the obligation to make payment for that part.

5.2. If VOGLAUER withdraws from a contract for reasons for which the customer is answerable without necessarily being culpable, or if customer withdraws from a contract without being entitled to do so, customer has the obligation to cover the costs of preparatory efforts by VOGLAUER (material purchased, special services, labour expenditure, etc.). VOGLAUER has the choice between the right to charge a lump sum of 25 % of the total amount of the contract without provision of specific evidence for individual efforts. Custom designs already produced by VOGLAUER must be paid for in full minus fitting and shipment costs.

6. Fitting

6.1. In cases where fitting is part of the agreement, customer has the obligation to provide for orderly vehicle access all the way to the rooms to be furnished. Where means of transportation such as cranes and lifts exist, these will be provided for use by VOGLAUER or its subcontractors free of charge.

6.2. Customer accepts liability for storage of the delivered goods on the construction site. This specifically includes theft-protected and dry storage on the construction site.

6.3. Customer will make all necessary provisions so that fitting can be performed without delay; specifically that assembly fitters not be hampered by other craftspeople. Also, the fitting areas of the rooms to be furnished must be heated, clean and sufficiently lighted where required and electric power is to be provided. Costs for electricity and water will be carried by the customer. Carpeted floors must be made slippery-proof and sufficiently covered to prevent soiling and damage by the customer.

6.4. If fitting includes connections with objects owned by the customer or third parties (e.g. Fastening to walls by drilling or chiselling), customer will warn VOGLAUER of perilous locations prior to the commencement of such work, specifically the exact location of electric cables, gas and water pipes and other supply systems will be communicated.

6.5. VOGLAUER has no obligation to inspect the properties of walls or objects to which VOGLAUER parts will be connected. Customer, on the other hand, has the obligation to notify VOGLAUER of properties of walls or objects possibly impairing simple and problem-free fitting. Any additional work and expense resulting from unpredicted properties of walls and objects will be charged to the customer.

6.6. Additional costs for overtime authorized and fitting delays caused by the customer as well as work not included in the order acknowledgement or work caused by inadequate environment will be charged separately. This will also be the case if VOGLAUER has offered fitting for a lump sum or for free as a discount.

6.7. Customer will at their own costs take care of cleaning of the rooms after fitting. Lack of contractual stipulations to the contrary, fitting services offered by VOGLAUER do not include fitting and connecting of electric equipment of any kind and lighting appliances. Unless agreed otherwise, such work is to be performed by authorized craftsmen at customer's own expense. Packaging material will be disposed of by the customer at his or her own expense.

7. Notification of Defects

Upon delivery, customers must immediately inspect the goods for possible defects. Incomplete or wrong shipments as well as complaints for recognisable defects will be directed to VOGLAUER in writing immediately upon receipt of the goods, non-recognisable defects immediately upon their discovery. The notification must indicate clearly the kind and extent of the alleged defect. In case of late notification of defects and errors, the shipment will be considered approved, in which case warranty claims are ruled out.

8. Warranty

VOGLAUER provides warranty for the delivered goods for a period of one year from the shipment date. For electric implements and lighting appliances delivered by VOGLAUER, the warranty period will be six months. In cases of justified and timely notification of defects, VOGLAUER will, reasonably taking into account customer's interest, provide warranty by improvement, price reduction or replacement (exchange) or take back the goods refunding the purchase price. The choice of the warranty method is VOGLAUER's. If VOGLAUER fails to meet warranty obligations within reasonable time, customer has the right to a reasonable price reduction or to withdraw from the contract. Activities started by VOGLAUER due to unjustified notifications of defect are considered purchase orders, and customers have the obligation to pay for the services rendered thereunder.

Excluded from the warranty are specifically:

- Goods provided by the customer;
- Damages resulting from deficiencies of the environment (e.g. faulty walls, construction material moisture, construction deficiencies, etc.);
- Compatibility of material used by VOGLAUER with other parts and properties of the rooms to furnish, such as other furnishing, lighting colours, heating, etc.;
- Deformation and crevices of massive wood used;
- Function of the delivered goods and suitability of the material used if the design has been made by the customer or his agent (e.g. architect);
- Minor deviations of hues and surface or veneer structures of the delivered goods;

9. Exclusions from Liability

9.1. VOGLAUER can be held liable for damages outside of the applicability of the product liability law only in cases of intent or gross negligence. Liability for slight negligence is foreclosed, as is compensation for consequential damage and financial loss, failure to realise savings or profit, losses from interest and damages from third party claims against the customer.

9.2. Within the applicability of the product liability law, VOGLAUER will be liable for personal damage and for material damage suffered by consumers. VOGLAUER will not be liable for material damage suffered by companies. Regress by the customer as defined in § 933b ABGB (Austrian General Law) is excluded. Claims for damages are in any event limited to a three-year period, counted from shipment.

9.3. The parties to a contract also mutually renounce all claims for any damages covered by an insurance held by the damaged party. This renunciation will not extend to damages inflicted by intent or gross negligence or if the insurer would be exempt from indemnification as a consequence of such renunciation.

9.4. Locking mechanisms or safe deposits provided by VOGLAUER will not constitute theft or break-in protection so that claims for damages resulting from these are excluded. A possibly required anti-theft device will therefore be acquired by the customer at his or her own cost and risk; VOGLAUER will not be held liable for locked items.

10. Payment

10.1. Invoices for the delivery of goods will be sent by email and are payable according to the stipulations of the individual contract. Unless stipulated otherwise, the customer will pay one third of the total amount quoted in the order acknowledgement as a down payment promptly upon order placement, one third two weeks prior to readiness for shipment and the remaining amount immediately upon receipt of the final invoice without discount. As far as there is no written agreement between the parties to a contract with regards to terms of payment, the amounts invoiced are payable directly upon receipt of the invoices without discounts. Bills of exchange or cheques will be accepted only on the grounds of separate written agreement and solely as payment. Discount and exchange expenses will be payable immediately by the customer. The customer recognises that VOGLAUER field staff are not entitled to collect payment.

10.2. In case of delayed payment, interest for delay amounting to 8 % above the then current base-lending rate will be charged. Set-off by the customer is ruled out except with receivables accepted in writing by VOGLAUER or ascertained in a legally binding manner.

10.3. If a customer cannot continue orderly business operations or forced sale of collaterals is in progress, if an act of protest is ongoing or delay or stop of payments is prevailing or if the customer has filed in or out of courts for a settlement system or bankruptcy has been declared, whether successful or not, VOGLAUER has the right to declare all outstanding bills from the business relationship due immediately, even if bills of exchange or cheques have been accepted or payment by instalments has been agreed. This also applies if and when the customer is late with payment or other circumstances indicate towards a questionable creditability. Furthermore, VOGLAUER has in the above-mentioned cases the right to demand advance payment or securities, realise securities provided or withdraw from the contract, claiming damages for default of performance.

10.4. Customers do not have the right to withhold payment due to alleged deficiencies, except if such deficiencies and the withholdable amounts have been accepted in writing by VOGLAUER or ascertained by a legal court. Any cession of customer receivables against VOGLAUER to third parties as well as any cession of rights and obligations of the closed contract is prohibited without prior written consent by VOGLAUER.

11. Reservation of Property Rights

11.1. The goods delivered remain the sole property of VOGLAUER until fulfilment of all obligations of the customer, specifically full payment of the purchase price including all side costs and interest, dues, fees, etc

11.2. Goods delivered for a particular building project, even if ordered, delivered and invoiced in tranches, are considered one coherent order. In such cases the reservation of property rights to all goods delivered will expire only when all payments resulting from the contracts therein have been made in full.

11.3. The customer has the right to sell goods delivered under this reservation of property rights only if they are dedicated goods for resale or after the reservation of property rights has expired or VOGLAUER expressly authorizes such sale. In case of resale of goods, the customer will cede all claims resulting from such sale to VOGLAUER. The customer has the obligation to make such cession recognizable by corresponding entries in his or her books and to disclose to VOGLAUER upon request the names of the debtors as well as to precisely specify the cession receivables. The cession will be accepted by VOGLAUER. Any dues or taxes related to such cession are to be carried by the customer, who will indemnify VOGLAUER of claims resulting thereof. VOGLAUER retains the right to disclose the cession and to realise the receivables cessed directly.

11.4. The customer has the obligation to sufficiently cover the reserved goods by insurance against common risks such as elementary events and to provide proof of such cover to VOGLAUER upon request. The customer hereby cedes given insurance claims to VOGLAUER. The customer also has the obligation to store the goods according to instructions given by VOGLAUER and to the state of the art. The customer has the obligation to tend to the goods during the reservation of property rights.

11.5. The customer will immediately notify VOGLAUER of access to the goods under reservation of VOGLAUER property rights by third parties (execution or listing for execution, other court orders or enactments). The customer will support and assist VOGLAUER in legal attempts to protect VOGLAUER's rights to the property and carry all associated costs if the customer has inflicted the threat to reserved VOGLAUER property.

11.6. In case of connection or mingling of reserved VOGLAUER property with other goods, VOGLAUER will gain joint ownership in the resulting goods proportionally to the value of the reserved property with respect to the value of the other goods at the time of connection or mingling. In case of sale of the resulting matter, the customer will cede the aliquot sales price in the sense of the stipulation above to VOGLAUER.

12. Intellectual Property

Trade marks, representations and the associated sketches, plans and descriptions are the intellectual property of VOGLAUER and must not be copied or disclosed to third parties without prior written consent by VOGLAUER.

13. Advertising

It is accepted that objects furnished by VOGLAUER may be used by VOGLAUER for purposes of advertising (reference lists, brochures, press releases, etc.) quoting customer names and using pictures of the furnished objects. The customer grants VOGLAUER the right to take pictures of the furnished objects.

14. Force Majeure

Events of force majeure affecting VOGLAUER or any of VOGLAUER's suppliers constitute the right for VOGLAUER to suspend deliveries for the duration of the hampering circumstances plus a reasonable lead-time without such suspension constituting a delay or the right for customers to fully or partially withdraw from the contract.

Events of force majeure are, among other things: All effects of the forces of nature such as earthquake, lightning, frost, storm, flood; furthermore, war, legal action, enactments by local authorities, detention, transport disruption, export, import or transit bans, international payment restrictions, raw material shortage and power loss; furthermore, operational disruptions such as explosion, fire, strike, sabotage and all other events which could not be prevented other than by unreasonably high costs or means not economically justifiable.

15. Data Privacy Assent

The customer expressly agrees that collection, processing and use of personal data provided by the customer be used by VOGLAUER for marketing purposes by installation of a customer data base and related activities. This assent specifically includes information transfer for purposes of advertising by fax, letter, email or any other method. This assent can be withdrawn by customers at all times with immediate effect for the future.

16. Final Provisions

16.1. All contracts closed by and with VOGLAUER as well as these terms and conditions are governed exclusively by Austrian law with the exclusion of the delegation norms and the UN convention on contract for the international sale of goods. All disputes arising directly or indirectly from contracts with VOGLAUER will be regulated at the appropriate court in the city of Salzburg, Austria. Place of performance for delivery and payment will be the principal office of VOGLAUER.

16.2. In case one or more of the stipulations herein or in a contract become invalid in full or in part, validity of the remaining stipulations will remain untouched. Fully or partly invalid stipulations will be considered replaced by provisions whose economical success approximates closest the original stipulation(s).

16.3. All changes or amendments of contracts between VOGLAUER and customers must be in writing, including the agreement to waive this stipulation. All declarations by VOGLAUER will only be legally binding if they are issued in writing by staff of the VOGLAUER principal office at Abtenau, Austria.

Design. Nature. Handcraft.



A commitment to nature and quality for over 80 years.

Innovative with consideration of the green and social environment



Ecolabels for

- Raw material and energy consumption
- Tested ingredients
- Emissions
- Disposal / recycling
- Packaging
- Power generation through in-house hydropower

Own hydropower



- Power generation through in-house hydropower

60 % of the energy consumption in production is covered by our own hydropower!

Energy/Recycling



- Thermal utilisation of 95 % of the wood waste
- Recycling of all water-based lacquers and wood strippers
- Energy comes from renewable energy sources
- Conscious waiver of air conditioning systems due to special night-ventilation system

Social responsibility



- Voglauer Academy – Training of the employees
- Free Shuttle-Service for employees
- Company cafeteria
- Support of public safety organisations



Wood from sustaining sources

Furniture – pure and genuine

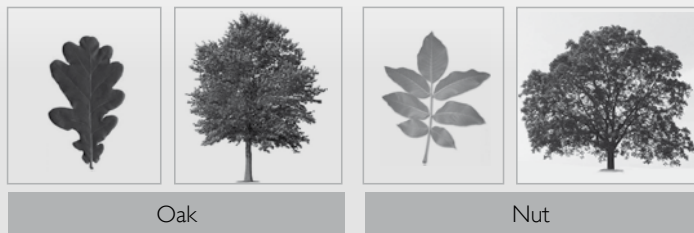

Oak

Nut

WOODEN FURNITURE for a pleasant atmosphere

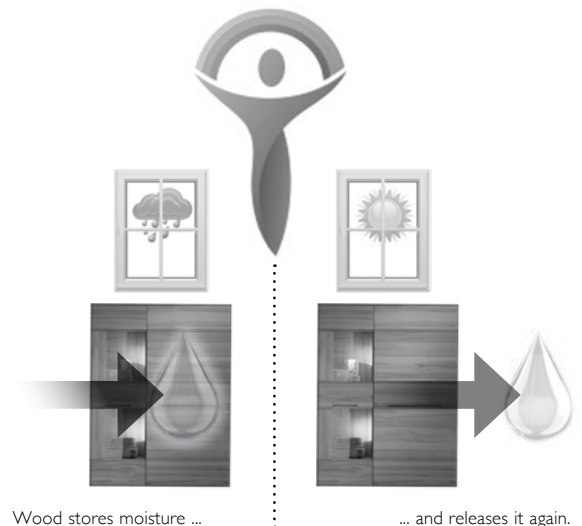

Wood stores moisture ...

... and releases it again.



F522L-L | Wildnuss geölt
Wild nut, oiled | Le noyer sauvage huilé



Strukturglas in Netzoptik und
Reliefrückwand aus Bergfichte.

Mesh design glass and relief
back wall in mountain spruce.

Verre en filigrane et panneau
arrière en épicéa des monta-
gnes avec relief.

VOGLAUER FURNITURE LINES



V-Solid / NEW 2015

- Dining
- Living



V-Alpin

- Dining
- Living
- Hall



V-Montana

- Dining
- Living
- Hall



V-Loft

- Dining
- Living



V-Vita

- Dining
- Living
- Hall



V-Soft

- Dining
- Living



V-Pur / NEUHEIT 2015

- Sleeping



V-Rivera

- Sleeping



V-Linea

- Sleeping

Request desired folders either by telephone or on our homepage.
It will be a pleasure for us to send them to you for free.

Voglauer traders:

You would like further information about our business or product lines? If so, please visit us online www.voglauer.com.



Follow us on Facebook!
Regular News from VOGLAUER.

Voglauer Möbelwerk Gschwandtner & Zwilling GmbH & Co KG
A-5441 Abtenau / Salzburger Land | Tel. +43 6243 2700-0 | Fax DW-210
Email: office@voglauer.com | www.voglauer.com