

VOGLAUER

Usoft



MODELS REGISTER

(valide from July 2015)

Please always indicate the following specifications:

MODEL: V-Soft **SO**

TYPE OF WOOD:



Heartwood beech, oiled KG



Wild oak brushed and oiled EG

LIGHTING:



LED-light with switch PLS



LED-light remote switch PLF

LEATHER: (Indicate leather number and description)



reinweiß LR



sahne LW



ziegelrot LY



burgundy LX



army green LZ



cognac LV



caffé LU



testa di moro LT



schwarz LS



kiesel LK



coco LO



stone LM



cenere LP



anthrazit LN



oceano LL

The colour samples are not suitable as color samples.

REFERENCE NUMBER:

Please indicate each article by its reference number. Attention: Indicate article-specific complements!

Ordering example:

- SH11T-R EG** Highboard 118, 2 doors, Glassdoor right, Wildoak oiled and scraped, W/D/H 117,7/40,1/154,8 cm
- SLS** Lighting per switch for the highboard
- SLT14-L EG** Lowboard deepened 141, 2 Drawers, left deepened side, Wildoak oiled and scraped, W/D/H 141,2/55,1-40,1/25,2 cm
- S-K** Cabel management, - Hatch incl. plug connector
- SB18LL LT EG** Upholstered seating bench with elongation, Leather LT testa di moro, Wildoak oiled and scraped, W/D/H 181,6/61,5/84 cm

ORDER MANAGEMENT AND TECHNICAL SUPPORT: Fax Nr.: +43 (0) 6243 2700 - 359



Daniel WALLINGER
Tel. +43 (0) 6243 2700-355
daniel.wallinger@voglauer.com



Andreas FEISER
Tel. +43 (0) 6243 2700-352
andreas.feiser@voglauer.com



Theresa WINTERSTELLER
Tel. +43 (0) 6243 2700-377
theresa.wintersteller@voglauer.com



Michael RESCHREITER
Tel. +43 (0) 6243 2700-357
michael.reschreiter@voglauer.com



Andrea GSENGER
Tel. +43 (0) 6243 2700-450
andrea.gsenger@voglauer.com

DELIVERY DATE INFORMATION: Fax: +43 (0) 6243 2700 - 315

Delivery: 5-7 weeks after having obtained commission

Helmut POSCH: helmut.posch@voglauer.com

Johann STEINER: johann.steiner@voglauer.com

VOGLAUER – CERTIFICATIONS AND AWARDS



Structural Design / Loading Capacities:

Corpus and Front side:	Solid wood		
Shelf rows:	Wooden shelf rows behind wooden doors, bronzed glass shelf rows behind transparent front glasses (Parsol bronze).		
Front glass:	All front glasses in browned (Parsol bronze) glass ESG (toughened safety glass)		
Drawers:	Dovetailed solid wood drawers (beech) with covered, smooth-running self-closing drawer runner		
Tables:	Solid wood		
Seating bench:	Framework solid wood, Seat and backrest upholstered with cattle hide napa leather		
Loading capacity:	Glass shelf rows 6 mm:	max. 5 kg	Drawers (until 80 cm in width): max. 10 kg
	Glass shelf rows 8 mm:	max. 10 kg	Drawers (more than 80 cm i.w.): max. 25 kg
	Wooden shelf rows:	max. 20 kg	Cantilever chairs: max. 120 kg

LED-Lighting (optional):

All lighting systems are installed and wired securely in(to) the furniture by VOGLAUER. Every illuminated element has its own controller and/or transformer and a power cable (approx. 2,5m) with EURO-plug. The lamps (illuminant) cannot be replaced in the fixtures.

Optional lighting:

- with internal light switch
- with remote-controlled radio circuit and dimmer (every element comes with its own handheld transmitter - subsequently several lighting systems can be adapted to one single transmitter)

Energy efficiency grade: A - A++

Performance/Consumption: LED-Spot: 2 Watt, LED-Stripe: 4,8 Watt/rm

Wood Composites - Indoor Climate:

Despite accurate processing wood is a living raw material; standing in reaction with air humidity and adapts to climatical conditions. Different colours, structures, small shakes, slight warping or open knots can be unavoidable consequences. An ideal indoor climate for wooden furniture would be approximately 18-23° C and 44-55 % air humidity. In order to avoid shakes and warpings, solid wood furniture should undergo low variability of the climate.

Oiled Surfaces:

All Voglauer surfaces equate to organic products concerning their environmental compatibility and ecology. The oiled surface is breathable and improves the indoor climate. The surface is antistatic, i.e. dust- and dirt-repellent.

Maintenance of oiled surfaces: To maintain the oiled Voglauer furniture's worth, it is advisable to oil it more or less every 6-8 months. Apply the Voglauer maintenance set (see: additional - „Maintenance oil“) thinly with a smooth, not fraying cloth and spread it evenly in fibre direction. Afterwards polish it with a dry cotton cloth. The surface will shine silk and velvety.

Upholstery - Leather:

Heavy-weight soft cattle hide napa leather with expressive grain. Each skin is unique and has undergone many production steps, hence slight colour differences are inevitable. This must be taken into account especially when comparing original furniture to their samples. Wriking is a natural procedure and therefore no decrease in quality. It occurs as a consequence of the leather's using or stretching.

Leather cleaning and maintenance (Leather maintenance products - see additional)

Every piece of leather furniture is exposed to daily pollution (esp. house dust deposits). Therefore it is important to clean the leather regularly. The mild and washing active substances of the VOGLAUER soft cleaner enable a gentle but thorough cleaning without harming the material. Stronger, not fatty pollution can be removed with the VOGLAUER intensive cleaner. After cleaning the leather has to be maintained. The VOGLAUER maintenance cream refreshes the dubbin, thus conserving the flexibility of the leather. As for maintenance frequency, it is recommended to apply this procedure 2-4 times per year, ideally before and after heating periods. In between the leather can easily be wiped off with a slightly damp natural fiber cloth.

Important Planning Advices:

- Check out constructional conditions, obstructions, measures and resilience at determination of material requirements to ensure a performance free of defects.
- Check out electrical conditions for connections and engineering (freely suspended lighting systems require cable ducts on or under plaster). Every illuminated element has its own power cable (approx. 2,5 m) with EURO-plug. In carcass furniture power connection for lighting (power point, cable exit) can be entirely located behind the rear panel (distance to wall approx. 23 mm).
- The door hinges are nickel-plated and 3-dimensional adjustable. Essential for the door's exact matching is to place the furniture on a flat bottom - in case of unevenness furniture items can be compensated with the included furniture wedges.
- All declared values in the price list are theoretical approximate dimensions and due to the aggregate tolerances they deviate from the real dimensions. The total dimensions don't comprehend handles and other irrelevant protruding component parts.















Installation of the Furniture:

Due to the big doors and full-opening drawers, furniture's standing on the ground has to be attached to the wall, to prevent it from tilting over. VOGLAUER includes the compatible installation-equipment for firm masonry. For drywalls / metal-stud walls the technician has to get compatible dowels and screws by himself. VOGLAUER don't assume any liability for the installation. Every furniture from Voglauer is assembled and performed individually. Some bulky goods are delivered in separate pieces. There are mounting instructions for not assembled goods.



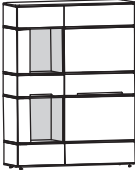
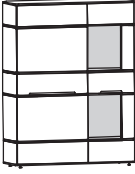







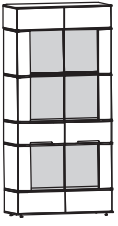
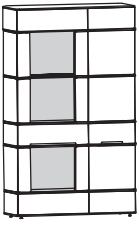

VOGLAUER Furniture Quality Certificate:

Every consignment comes with a VOGLAUER quality certificate (Online Download: www.voglauer.com). VOGLAUER do not assume any liability for not conforming to care and maintenance instructions or misuse.



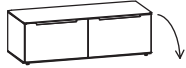







Sideboards, Highboards

	<p>left and right 2 shelf rows each</p>  <p>W/D/H 141,2/47,1/90 cm</p>	<p>left: 2 shelf rows</p>  <p>W/D/H 141,2/47,1/90 cm</p>	<p>right: 2 shelf rows</p>  <p>W/D/H 141,2/47,1/90 cm</p>	<p>left and right 2 shelf rows each</p>  <p>W/D/H 188,2/47,1/90 cm</p>	<p>left and right 2 shelf rows each</p>  <p>W/D/H 211,7/47,1/90 cm</p>	
Description	Sideboard 141, 2 Doors	Sideboard 141, 1 Door, 4 Drawers, Door stop left	Sideboard 141, 1 Door, 4 Drawers, Door stop right	Sideboard 188, 2 Doors, 4 Drawers	Sideboard 212, 2 Doors, 4 Drawers	
CORE BEECH						
WILD OAK						
	<p>2 Shelf rows at the top</p>  <p>W/D/H 70,7/40,1/154,8cm</p>	<p>2 Shelf rows & 2 Glass shelf rows</p>  <p>W/D/H 70,7/40,1/154,8cm</p>	<p>left: 4 Shelf rows right: 2 Shelf rows</p>  <p>W/D/H 117,7/40,1/154,8cm</p>	<p>left: 2 Shelf rows right: 4 shelf rows</p>  <p>W/D/H 117,7/40,1/154,8cm</p>	<p>left: 2 Glass shelf rows, 2 Wooden shelf rows right: 2 Wooden shelf rows</p>  <p>W/D/H 117,7/40,1/154,8cm</p>	<p>left: 2 Wooden shelf rows right: 2 Glass shelf rows 2 Wooden shelf rows</p>  <p>W/D/H 117,7/40,1/154,8cm</p>
Description	Highboard 71, 1 Door, 3 Drawers Stop left Stop right	Highboard 71, 1 Door Stop left Stop right	Highboard 118, 2 Wooden Doors, 3 Drawers Narrow door left Narrow door right	Highboard 118, 2 Doors, 3 Drawers Glass door left Glass door right	Highboard 118, 2 Doors, 3 Drawers Glass door left Glass door right	
CORE BEECH						
WILD OAK						
Lighting per switch (S-LS)						
Lighting per radio (S-LF)						
	<p>left: 2 Glass shelf rows, 2 Wooden shelf rows right: 4 Wooden shelf rows</p>  <p>W/D/H 117,7/40,1/154,8cm</p>	<p>left: 4 Wooden shelf rows right: 2 Glass shelf rows, 2 Wooden shelf rows</p>  <p>W/D/H 117,7/40,1/154,8cm</p>	<p>left & right: 2 Shelf rows each center: 2 Shelf rows</p>  <p>W/D/H 164,7/40,1/154,8cm</p>	<p>left & right: 4 Shelf rows each center: 2 Shelf rows</p>  <p>W/D/H 164,7/40,1/154,8cm</p>	<p>left & right: 2 Glass shelf rows & 2 Wooden Shelf rows each center: 4 Wooden Shelf rows</p>  <p>W/D/H 164,7/40,1/154,8cm</p>	
Description	Highboard 118, 2 Doors, Glass door left	Highboard 118, 2 Doors, Glass door right	Highboard 165, 3 Doors, 3 Drawers	Highboard 165, 3 Doors, 3 Drawers	Highboard 165, 3 Doors	
CORE BEECH						
WILD OAK						
Lighting per switch (S-LS)						
Lighting per radio (S-LF)						

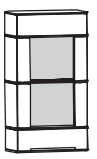
Cabinets, Lowboards

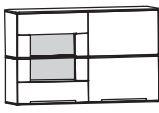
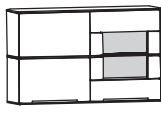
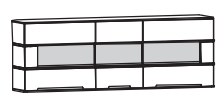
	<p>3 Glass shelf rows 2 Wooden shelf rows</p>  <p>W/D/H 70,7/40,1/198 cm</p>	<p>3 Glass shelf rows 2 Wooden shelf rows</p>  <p>W/D/H 94,2/40,1/198 cm</p>	<p>left: 3 Glass shelf rows, 2 Wooden shelf rows right: 5 Wooden shelf rows</p>  <p>W/D/H 117,7/40,1/198 cm</p>	<p>left: 5 Wooden shelf rows right: 3 Glass shelf rows, 2 Wooden shelf rows</p>  <p>W/D/H 117,7/40,1/198 cm</p>
Description	Cabinet 71, 1 Door Door stop left Door stop right	Cabinet 94, 2 Doors	Cabinet 118, 2 Doors, left	Cabinet 118, 2 Doors, right
CORE BEECH				
WILD OAK				
Lighting per switch (S-LS)				
Lighting per radio (S-LF)				
Utilizable Height of Drawers 13 cm				
	 <p>W/D/H 141,2/55,1-40,1/25,2 cm</p>	 <p>W/D/H 141,2/40,1-55,1/25,2 cm</p>	 <p>W/D/H 211,7/55,1-40,1/25,2 cm</p>	 <p>W/D/H 211,7/40,1-55,1/25,2 cm</p>
Description	Lowboard deepened 141, 2 Drawers, left	Lowboard deepened 141, 2 Drawers, right	Lowboard deepened 212, 3 Drawers, left	Lowboard deepened 212, 3 Drawers, right
CORE BEECH				
WILD OAK				
Cable management - Hatch incl. plug connector (S-K)				
Utilizable Height of Drawers 13 cm				
	 <p>W/D/H 141,2/55,1/25,2 cm</p>	 <p>W/D/H 211,7/55,1/25,2 cm</p>	 <p>W/D/H 141,2/55,1/46,8 cm</p>	 <p>W/D/H 141,2/55,1/46,8 cm</p>
Description	Lowboard 141, 2 Drawers	Lowboard 212, 3 Drawers	Lowboard 141, 4 Drawers	Lowboard 141, 2 Hatches
CORE BEECH				
WILD OAK				
Cable management - Hatch incl. plug connector (S-K)				
	<p>Utilizable Height of Drawers 13 cm</p>  <p>W/D/H 141,2/55,1/46,8 cm</p>	 <p>W/D/H 141,2/55,1/46,8 cm</p>	<p>Utilizable Height of Drawers top 13 cm, bottom 25 cm</p>  <p>W/D/H 211,7/55,1/68,4 cm</p>	<p>Conducts signals of customary remote control through closed furniture front.</p> 
Description	Lowboard 141, 3 Drawers left	Lowboard 141, 3 Drawers right	Lowboard high 212, 6 Drawers	Infrarot-Repeater
CORE BEECH				
WILD OAK				
Lighting per switch (S-LS)				
Lighting per radio (S-LF)				
Cable management - Hatch incl. plug connector (S-K)				

Suspended elements, Boards, TV-Panels

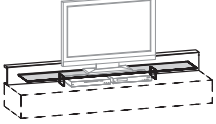
	<p>Utilizable Height of Drawers: left: bottom 15 cm, top 13 cm, center and right: 34 cm</p>  <p>W/D/H 211,7/40,1/44,8 cm</p>	<p>Utilizable Height of Drawers: left and center: 34 cm, right: bottom 15 cm, top 13 cm</p>  <p>W/D/H 211,7/40,1/44,8 cm</p>	 <p>W/D/H 141,2/35,1/44,8 cm</p>	 <p>W/D/H 141,2/35,1/44,8 cm</p>	
Description	Suspended element bottom 212, 4 Drawers, left	Suspended element bottom 212, 4 Drawers, right	Suspended element 141, 1 Hatch downwards	Suspended element 141, 1 Hatch upwards	
CORE BEECH					
WILD OAK					
Lighting per switch (S-LS)					
Lighting per radio (S-LF)					
	<p>3 Wooden shelf rows</p>  <p>W/D/H 70,7/35,1/131,2 cm</p>	<p>2 Glass shelf rows 1 Wooden shelf row</p>  <p>W/D/H 70,7/35,1/131,2 cm</p>	<p>left: 2 Glass shelf rows, 1 Wooden shelf row right: 3 Wooden shelf rows</p>  <p>W/D/H 117,7/35,1/131,2 cm</p>	<p>left: 3 Wooden shelf rows right: 2 Glass shelf rows, 1 Wooden shelf row</p>  <p>W/D/H 117,7/35,1/131,2 cm</p>	
Description	Suspended element 71, 1 Wooden door Door stop left Door stop right	Suspended element 71, 1 Glass door Door stop left Door stop right	Suspended element 118, 2 Doors, left	Suspended element 118, 2 Doors, right	
CORE BEECH					
WILD OAK					
Lighting per switch (S-LS)					
Lighting per radio (S-LF)					
	<p>left: 1 Glass shelf row, 1 Wooden shelf row right: 2 Wooden shelf rows</p>  <p>W/D/H 141,2/35,1/88 cm</p>	<p>left: 2 Wooden shelf rows right: 1 Glass shelf row, 1 Wooden shelf row</p>  <p>W/D/H 141,2/35,1/88 cm</p>	<p>left: 2 Doors, 2 Wooden shelf rows right: 1 Door, 2 Wooden shelf rows</p>  <p>W/D/H 188,2/35,1/66,4 cm</p>	<p>Mirror browned (Parsol bronze)</p>  <p>W/D/H 114,6/3,1/45,7 cm</p>	
Description	Suspended element 141, 2 Doors, left	Suspended element 141, 2 Doors, right	Suspended element 188, 3 Doors	Mirror 115/46 cm	
CORE BEECH					
WILD OAK					
Lighting per switch (S-LS)					
Lighting per radio (S-LF)					
	<p>Glass shelf browned (Parsol bronze), max. 10 kg resilient</p>  <p>W/D/H 188,2/21,2/21,2 cm</p>			<p>Glass shelf browned (Parsol bronze), max. 40 kg resilient Cable management inkl. 4-plug connector with switch</p>  <p>W/D/H 141,2/40,1/63 cm</p>	
	 <p>W/D/H 141,2/21,2/41,4 cm</p>			 <p>W/D/H 211,7/40,1/19,8 cm</p>	
Description	Wall shelf 188 with glass shelf	Wall panel 141 with Glass shelf	Wall panel 212 with glass shelf	TV-Panel with glass media board	TV-Panel with glass media board
CORE BEECH					
WILD OAK					
Lighting per switch (S-LS)					
Lighting per radio (S-LF)					

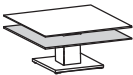
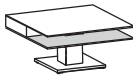
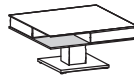
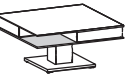
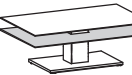
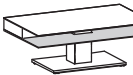
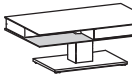
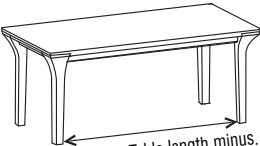
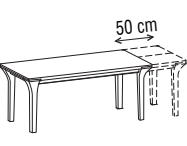
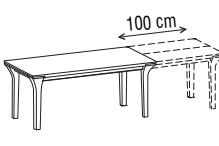
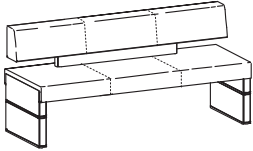
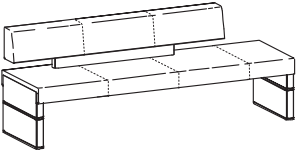
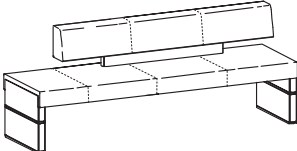

Tables, Seats

		Coffee tables 90/90 cm				Coffee tables 75/120 cm			
									
		W/D/H 90/90/45,5 cm	W/D/H 90/90/45,5 cm	W/D/H 90/90/45,5 cm	W/D/H 90/90/37,8 cm height adjustable 37,8 to 73,8 cm	W/D/H 75/120/45,5 cm	W/D/H 75/120/45,5 cm	W/D/H 75/120/45,5 cm	
Description		Coffee table 90/90 cm, without drawers	Coffee table 90/90 cm, with 1 drawer	Coffee table 90/90 cm, with 2 drawers	Coffee table 90/90 cm, height adjustable, 2 drawers	Coffee table 75/120 cm, without drawers	Coffee table 75/120 cm, with 1 drawer	Coffee table 75/120 cm, with 2 drawers	
CORE BEECH									
WILD OAK									
		 Internal dimension = Table length minus. 32 cm Table height 76,5 cm					 50 cm	 100 cm length minimum 180 cm	
Description		Dining room table					Surcharge Elongation 50 cm	Surcharge Elongation 100 cm	
Dim. W/L		90/140 cm	90/160 cm	90/180 cm	90/200 cm	100/160 cm	100/180 cm	100/200 cm	
							+ 50 cm	+ 100 cm	
CORE BEECH									
WILD OAK									
		Seat and backrest upholstered with cattle hide napa leather accord. to coll. Seat height ca. 49 cm							
									
Description		Upholstered seating bench 142 cm		Upholstered seating bench 162 cm		Upholstered seating bench 182 cm		Upholstered seating bench 202 cm	
Dim. W/D/H		141,6/61,5/84 cm		161,6/61,5/84 cm		181,6/61,5/84 cm		201,6/61,5/84 cm	
CORE BEECH									
WILD OAK									
		Seat and backrest upholstered with cattle hide napa leather accord. to coll. Seat height ca. 49 cm							
									
Description		Upholstered seating bench, backrest left				Upholstered seating bench, backrest right			
Dim. W/D/H		181,6/61,5/84 cm	201,6/61,5/84 cm	221,6/61,5/84 cm	241,6/61,5/84 cm	181,6/61,5/84 cm	201,6/61,5/84 cm	221,6/61,5/84 cm	241,6/61,5/84 cm
Suitable table size		140 oder 180 cm	160 oder 200 cm	180 cm	200 cm	140 oder 180 cm	160 oder 200 cm	180 cm	200 cm
CORE BEECH									
WILD OAK									

Seat upholstery: Foamed material 35 mm
Density 50
Hardness 75

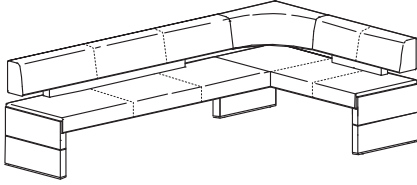

Seat height ca. 49 cm
total height ca. 84 cm
Cattle hide napa leather upholstery

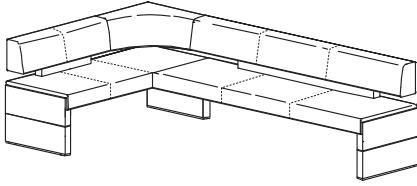
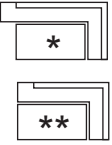
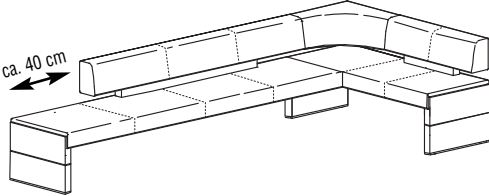
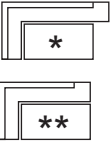
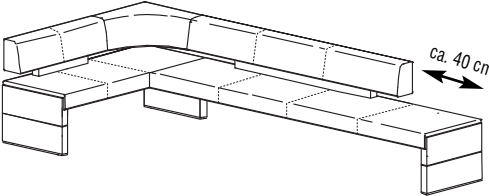

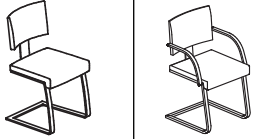

Corner Seats

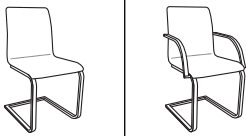
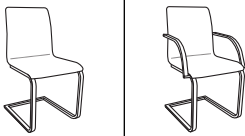
Outline suiting table size 							
Description	Upholstered corner (short side at the right)						
Side length L/R	202,3/153,1 cm	222,3/153,1 cm	242,3/153,1 cm	262,3/153,1 cm	222,3/163,1 cm	242,3/163,1 cm	262,3/163,1 cm
Suitable table size	90/140 cm	90/160 cm	90/180 cm	90/200 cm	100/160 cm	100/180 cm	100/200 cm
CORE BEECH							
WILD OAK							
Outline suiting table size 							
Description	Upholstered corner (short side at the left)						
Side length L/R	153,1/202,3 cm	153,1/222,3 cm	153,1/242,3 cm	153,1/262,3 cm	163,1/222,3 cm	163,1/242,3 cm	163,1/262,3 cm
Suitable table size	90/140 cm	90/160 cm	90/180 cm	90/200 cm	100/160 cm	100/180 cm	100/200 cm
CORE BEECH							
WILD OAK							
Outline suiting table size 							
Description	Upholstered corner with seat elongation (short side at the right)						
Side length L/R	242,3/153,1 cm	262,3/153,1 cm	282,3/153,1 cm	302,3/153,1 cm	262,3/163,1 cm	282,3/163,1 cm	302,3/163,1 cm
Suitable table size	*90/140 cm **90/180 cm	*90/160 cm **90/200 cm	*90/180 cm	*90/200 cm	*100/160 cm **100/200 cm	*100/180 cm	*100/200 cm
CORE BEECH							
WILD OAK							
Outline suiting table size 							
Description	Upholstered corner with seat elongation (short side at the left)						
Side length L/R	153,1/242,3 cm	153,1/262,3 cm	153,1/282,3 cm	153,1/302,3 cm	163,1/262,3 cm	163,1/282,3 cm	163,1/302,3 cm
Suitable table size	*90/140 cm **90/180 cm	*90/160 cm **90/200 cm	*90/180 cm	*90/200 cm	*100/160 cm **100/200 cm	*100/180 cm	*100/200 cm
CORE BEECH							
WILD OAK							

<p>Seat height ca. 48 cm</p>  <p>W/D/H ca. 44/55/100 cm</p>	<p>Seat upholstered with cattle hide napa leather, wooden backrest</p>
Description	Upholstered chair 99
CORE BEECH	
WILD OAK	

<p>Seat height ca. 48 cm</p>  <p>W/D/H 47/57/86 cm W/D/H 53/57/86 cm</p>	<p>Further VOGLAUER chairs - Seat upholstered with cattle hide napa leather, wooden backrest (Oak unbrushed)</p>
Description	Cantilever chair Cantilever chair with armrests
CORE BEECH	
WILD OAK	

<p>Seat height ca. 48 cm</p>	<p>Further VOGLAUER chairs - Seat upholstered with cattle hide napa leather (Oak unbrushed)</p>						<p>(CLV board, edged around) max. Length 252 cm max. Width 110 cm Thickness of material: 14, 20, or 23 mm</p>  <p>price per m² (calculated min. 0,5 m²)</p>
	<p>Backrest coating leather</p>  <p>W/D/H 46/54/90 cm W/D/H 53/54/90 cm</p>	<p>Wooden backshell</p>  <p>W/D/H 46/54/90 cm W/D/H 53/54/90 cm</p>	 <p>W/D/H 47/53/86 cm</p>	 <p>W/D/H 53/53/86 cm</p>			
Description	Cantilever chair 2 Cantilever chair 2 with armrests	Cantilever chair 3 Cantilever chair 3 with armrests	Upholstered chair 82	Upholstered chair 82, with armrests	Cover plate double sided veneered		
CORE BEECH							
WILD OAK							

	<p>WOOD MAINTENANCE</p>			<p>LEATHER MAINTENANCE</p>		
	<p>250 ml Voglauer Maintenance oil and polishing cloth</p>  <p>The original Voglauer wood maintenance oil cleans and refreshes the surfaces and at the same time creates a breathable protective film.</p>	<p>Repair set comprises: 100 ml Voglauer cleanser 100 ml Surface oil Scotch-Brite and polishing cloths</p>  <p>In order to fix little surface damages and impureness.</p> <p>Indicate Type of wood!</p>	<p>200 ml soft cleaner 200 ml maintenance cream with light protection Sponge and cloths</p>  <p>The original Voglauer leather maintenance set for thorough and yet gentle cleaning as well as impregnation of leather. Recommended: 2 - 4 applications per year.</p>	<p>Contents 200 ml</p>  <p>To remove strong, not fatty pollution and dust deposit on the leather.</p>	<p>Contents 200 ml</p>  <p>Highly effective impregnation and light protection. The dubbin gets refreshed and the leather stays soft and sleek, retarding the fading of the color.</p>	<p>Contents 200 ml</p>  <p>To refresh faded and galled leather. Recommended: Impregnation with maintenance cream afterwards</p> <p>Indicate Color of leather!</p>
Description	Maintenance set for oiled surfaces	Repair set for oiled surfaces	Leather maintenance set	Leather intensive cleaner	Leather maintenance cream	Leather color lotion
Price						

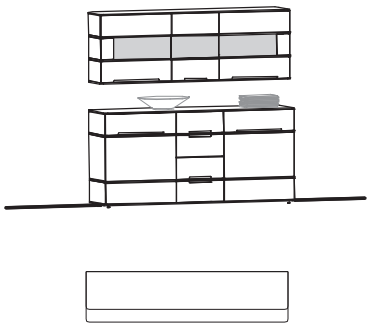
<p>SUGGESTION 122 W/D/H 188,2 / 47,1 / 182 cm</p>  <p>(Suggestions always without extra charge articles)</p>		
	CORE BEECH	
	WILD OAK	
	Lighting per switch (S-LS)	
	Lighting per radio (S-LF)	
	<p>Suggestion (ill.) compromises:</p> <ul style="list-style-type: none"> 1x Sideboard 188, 2 Doors, 4 Drawers 1x Suspended element 188, 3 Doors 	

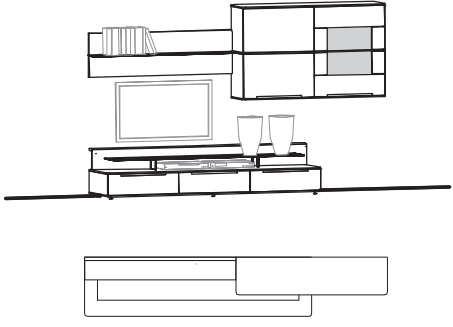
<p>SUGGESTION 139 W/D/H 282,3 / 55,1 / 176 cm</p>  <p>(Suggestions always without extra charge articles)</p>		
	CORE BEECH	
	WILD OAK	
	Lighting per switch (S-LS)	
	Lighting per radio (S-LF)	
	<p>Suggestion (ill.) compromises:</p> <ul style="list-style-type: none"> 1x Lowboard 212, 3 Drawers 1x TV-Panel 212 with glass media board 1x Wall panel 141 with glass shelf 1x Suspended element 141, 2 Doors, right 	

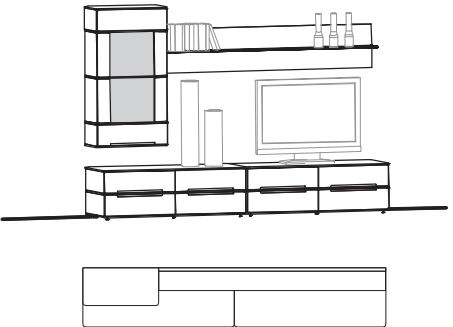
<p>SUGGESTION 156 W/D/H 282,4 / 55,1 / 198 cm</p>  <p>(Suggestions always without extra charge articles)</p>		
	CORE BEECH	
	WILD OAK	
	Lighting per switch (S-LS)	
	Lighting per radio (S-LF)	
	<p>Cable management for left element of drawers</p> <p>Cable management for right element of drawers</p> <p>Suggestion (ill.) compromises:</p> <ul style="list-style-type: none"> 2x Element of drawers 141, 4 Drawers 1x Suspended element 71, 1 Door, left 1x Wall panel 212 with Glass shelf 	

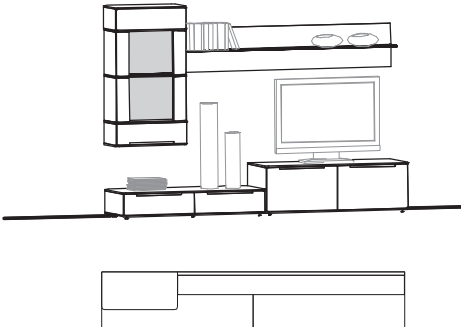
<p>SUGGESTION 164 W/D/H 282,4 / 55,1 / 198 cm</p>  <p>(Suggestions always without extra charge articles)</p>		
	CORE BEECH	
	WILD OAK	
	Lighting per switch (S-LS)	
	Lighting per radio (S-LF)	
	<p>Cable management for left element of drawers</p> <p>Cable management for right element of drawers</p> <p>Suggestion (ill.) compromises:</p> <ul style="list-style-type: none"> 1x Lowboard 141, 2 Drawers 1x Lowboard 141, 2 Hatches 1x Suspended element 71, 1 Door, left 1x Wall panel 212 with Glass shelf 	

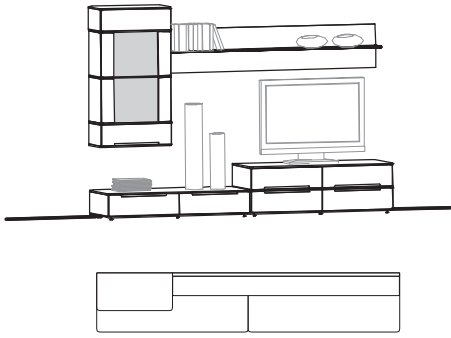
<p>SUGGESTION 173 W/D/H 282,4 / 55,1 / 198 cm</p>  <p>(Suggestions always without extra charge articles)</p>	CORE BEECH	
	WILD OAK	
	Lighting per switch (S-LS)	
	Lighting per radio (S-LF)	
	Cable management for left Lowboard	
	Cable management for right Lowboard	
	<p>Suggestion (ill.) compromises:</p> <ul style="list-style-type: none"> 1x Lowboard 141, 2 Laden 1x Element of drawers 141, 4 Drawers 1x Suspended element 71, 1 Door, left 1x Wall panel 212 with Glass shelf 	

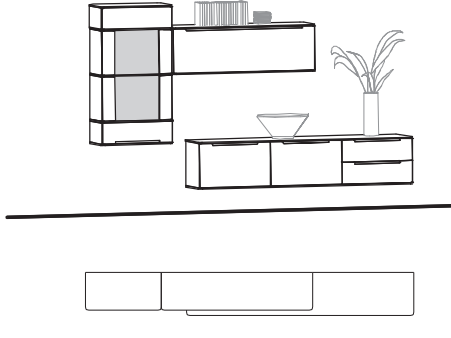
<p>SUGGESTION 190 W/D/H 306 / 55,1 / 198 cm</p>  <p>(Suggestions always without extra charge articles)</p>	CORE BEECH	
	WILD OAK	
	Lighting per switch (S-LS)	
	Lighting per radio (S-LF)	
	<p>Suggestion (ill.) compromises:</p> <ul style="list-style-type: none"> 1x Suspended element bottom 212, 4 Drawers, right 1x Suspended element 71, 1 Door, left 1x Suspended element 141, 1 Hatch downwards 	

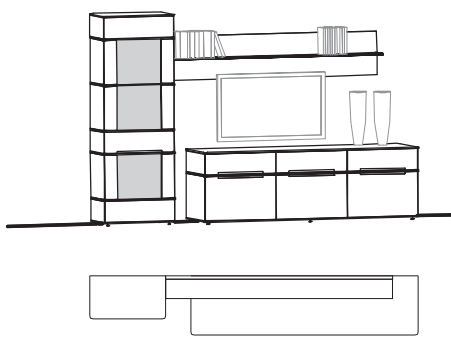
<p>SUGGESTION 207 W/D/H 306 / 55,1 / 198 cm</p>  <p>(Suggestions always without extra charge articles)</p>	CORE BEECH	
	WILD OAK	
	Lighting per switch (S-LS)	
	Lighting per radio (S-LF)	
	Cable management for Lowboard	
	<p>Suggestion (ill.) compromises:</p> <ul style="list-style-type: none"> 1x Cabinet 71, 1 Door, left 1x Lowboard high 212, 6 Drawers 1x Wall panel 212 with Glass shelf 	

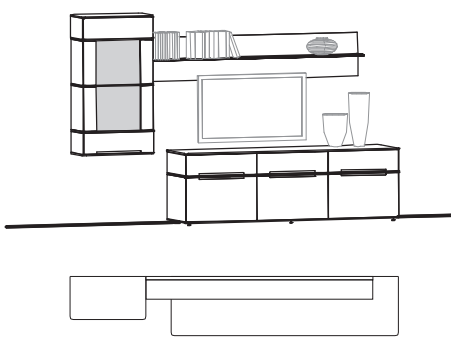
<p>SUGGESTION 224 W/D/H 306 / 55,1 / 198 cm</p>  <p>(Suggestions always without extra charge articles)</p>	CORE BEECH	
	WILD OAK	
	Lighting per switch (S-LS)	
	Lighting per radio (S-LF)	
	Cable management for Lowboard	
	<p>Suggestion (ill.) compromises:</p> <ul style="list-style-type: none"> 1x Lowboard high 212, 6 Drawers 1x Suspended element 71, 1 Door, left 1x Wall panel 212 with Glass shelf 	

SUGGESTION 258	W/D/H 317 / 40,1 / 198 cm		
		CORE BEECH	
		WILD OAK	
		Lighting per switch (S-LS)	
		Lighting per radio (S-LF)	
Suggestion (ill.) comprises:		1x Cabinet 71, 1 Door, left 1x Suspended element bottom 212, 4 Drawers, right 1x Wall panel 212 with Glass shelf	
(Suggestions always without extra charge articles)			

SUGGESTION 275	W/D/H 317 / 55,1 / 198 cm		
		CORE BEECH	
		WILD OAK	
		Lighting per switch (S-LS)	
		Lighting per radio (S-LF)	
Suggestion (ill.) comprises:		1x Lowboard deepened 141, 2 Drawers, right 1x Lowboard deepened 141, 2 Drawers, left 1x TV-Panel 212 with glass media board 1x Suspended element 71, 1 Door, left 1x Wall panel 212 with Glass shelf	
(Suggestions always without extra charge articles)			

SUGGESTION 292	W/D/H 329,3 / 40,1 / 154,8 cm		
		CORE BEECH	
		WILD OAK	
		Lighting per switch (S-LS)	
		Lighting per radio (S-LF)	
Suggestion (ill.) comprises:		1x SH11TL-L Highboard 118, 2 Doors, 3 Drawers, left 1x SHU21-R Suspended element bottom 212, 4 Drawers, right	
(Suggestions always without extra charge articles)			

SUGGESTION 309	W/D/H 329,4 / 55,1 / 154,8 cm		
		CORE BEECH	
		WILD OAK	
		Lighting per switch (S-LS)	
		Lighting per radio (S-LF)	
Suggestion (ill.) comprises:		1x Highboard 118, 2 Doors, left 1x Lowboard deepened 212, 3 Drawers, right 1x TV-Panel 212 with glass media board 1x Wall panel 212 with Glass shelf	
(Suggestions always without extra charge articles)			

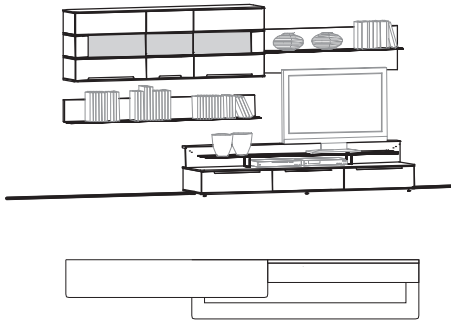
SUGGESTION 314	W/D/H 329,1 / 55,1 / 176 cm		CORE BEECH	
			WILD OAK	
			Lighting per switch (S-LS)	
			Lighting per radio (S-LF)	
			Suggestion (ill.) compromises:	
			1x	Lowboard 212, 3 Laden
1x	TV-Paneel 212 mit Glas-Mediaboard			
1x	Wandbord 188 with glass board			
1x	Hängeelement 188, 3-türig			
1x	Wandpaneel 141 with glass board			
(Suggestions always without extra charge articles)				

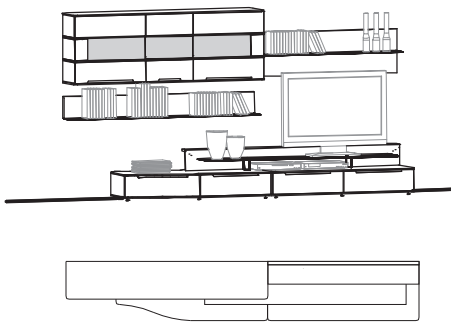
SUGGESTION 318	W/D/H 329,1 / 55,1 / 176 cm		CORE BEECH	
			WILD OAK	
			Lighting per switch (S-LS)	
			Lighting per radio (S-LF)	
			Suggestion (ill.) compromises:	
			1x	Lowboard deepened 141, 2 Drawers, right
1x	Lowboard 141, 2 Drawers			
1x	TV-Panel 212 with glass media board			
1x	Wall panel 188 with glass shelf			
1x	Suspended element 188, 3 Doors			
1x	Wall panel 141 with glass shelf			
(Suggestions always without extra charge articles)				

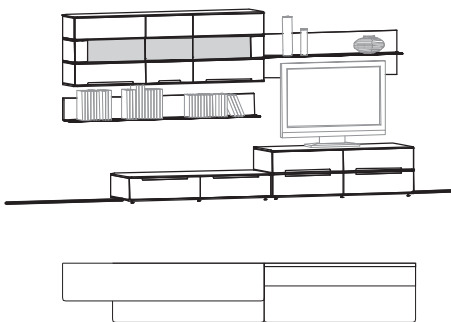
SUGGESTION 326	W/D/H 329,1 / 55,1 / 176 cm		CORE BEECH	
			WILD OAK	
			Lighting per switch (S-LS)	
			Lighting per radio (S-LF)	
			Cable management for left Lowboard	
			Cable management for right element of drawers	
Suggestion (ill.) compromises:				
1x	Lowboard 141, 2 Drawers			
1x	Element of drawers 141, 4 Drawers			
1x	Wall panel 188 with glass shelf			
1x	Suspended element 188, 3 Doors			
1x	Wall panel 141 with glass shelf			
(Suggestions always without extra charge articles)				

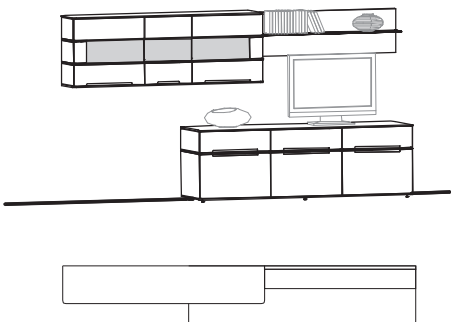
SUGGESTION 343	W/D/H 329,3 / 55,1 / 176 cm		CORE BEECH	
			WILD OAK	
			Lighting per switch (S-LS)	
			Lighting per radio (S-LF)	
			Cable management for Lowboard	
			Suggestion (ill.) compromises:	
1x	Lowboard high 212, 6 Drawers			
1x	Suspended element 188, 3 Doors			
1x	Wall panel 141 with glass shelf			
(Suggestions always without extra charge articles)				

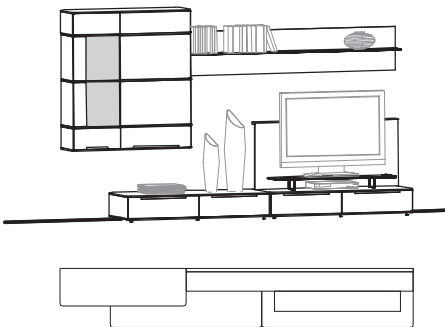
<p>SUGGESTION 352 W/D/H 329,3 / 55,1 / 198 cm</p>  <p>(Suggestions always without extra charge articles)</p>	CORE BEECH	
	WILD OAK	
	Lighting per switch (S-LS)	
	Lighting per radio (S-LF)	
	Cable management for left Lowboard	
	<p>Suggestion (ill.) comprises:</p> <ul style="list-style-type: none"> 2x Lowboard 141, 2 Drawers 1x TV-Panel 141 with glass media board 1x Suspended element 118, 2 Doors, left 1x Wall panel 212 with glass shelf 	

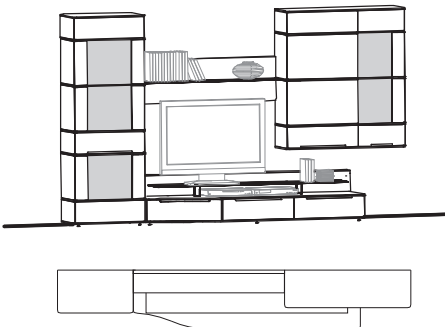
<p>SUGGESTION 360 W/D/H 329,4 / 55,1 / 198 cm</p>  <p>(Suggestions always without extra charge articles)</p>	CORE BEECH		
	WILD OAK		
	Lighting per switch (S-LS)		
	Lighting per radio (S-LF)		
	<p>Suggestion (ill.) comprises:</p> <ul style="list-style-type: none"> 1x Cabinet 71, 1 Door, left 1x Lowboard deepened 212, 3 Drawers, right 1x TV-Panel 212 with glass media board 1x Wall panel 141 with glass shelf 1x Suspended element 118, 2 Doors, right 		

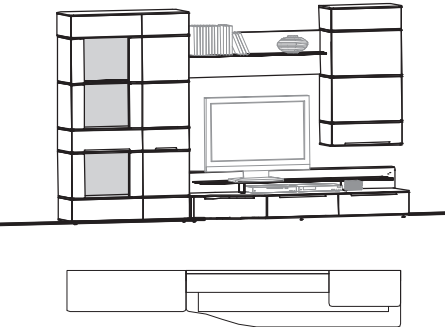
<p>SUGGESTION 368 W/D/H 329,4 / 55,1 / 198 cm</p>  <p>(Suggestions always without extra charge articles)</p>	CORE BEECH		
	WILD OAK		
	Lighting per switch (S-LS)		
	Lighting per radio (S-LF)		
	<p>Suggestion (ill.) comprises:</p> <ul style="list-style-type: none"> 1x Cabinet 118, 2 Doors, left 1x Lowboard deepened 212, 3 Drawers, right 1x TV-Panel 212 with glass media board 1x Wall panel 141 with glass shelf 1x Suspended element 71 with wooden door, right 		

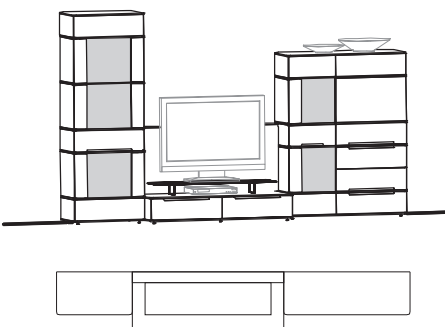
<p>SUGGESTION 377 W/D/H 329,6 / 55,1 / 198 cm</p>  <p>(Suggestions always without extra charge articles)</p>	CORE BEECH		
	WILD OAK		
	Lighting per switch (S-LS)		
	Lighting per radio (S-LF)		
	<p>Suggestion (ill.) comprises:</p> <ul style="list-style-type: none"> 1x Cabinet 71, 1 Door, left 1x Lowboard 141, 2 Drawers 1x TV-Panel 141 with glass media board 1x Highboard 118, 2 Doors, 3 Drawers, left 		

<p>SUGGESTION 394 W/D/H 352,9 / 55,1 / 198 cm</p>  <p>(Suggestions always without extra charge articles)</p>	CORE BEECH	
	WILD OAK	
	Lighting per switch (S-LS)	
	Lighting per radio (S-LF)	
	Cable management for right element of drawers	
	<p>Suggestion (ill.) compromises:</p> <ul style="list-style-type: none"> 1x Cabinet 71, 1 Door, left 1x Lowboard 141, 2 Drawers 1x Element of drawers 141, 3 Drawers, left 1x TV-Panel 141 with glass media board 1x Wall panel 141 with glass shelf 1x Suspended element 141, 2 Doors, right 	

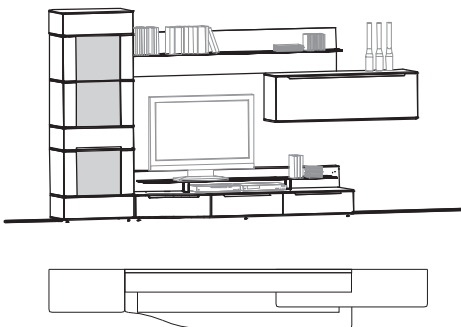
<p>SUGGESTION 411 W/D/H 352,9 / 55,1 / 198 cm</p>  <p>(Suggestions always without extra charge articles)</p>	CORE BEECH		
	WILD OAK		
	Lighting per switch (S-LS)		
	Lighting per radio (S-LF)		
	<p>Suggestion (ill.) compromises:</p> <ul style="list-style-type: none"> 1x Cabinet 71, 1 Door, left 1x Lowboard deepened 212, 3 Drawers, right 1x TV-Panel 212 with glass media board 1x Suspended element 141, 1 Hatch downwards 1x Wall panel 212 with glass shelf 		

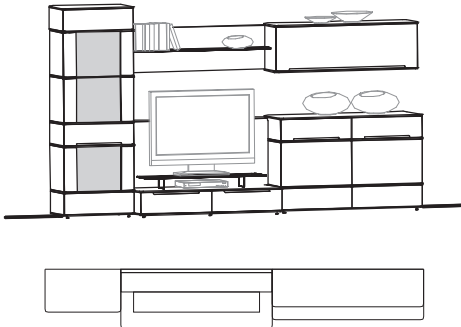
<p>SUGGESTION 428 W/D/H 352,9 / 55,1 / 198 cm</p>  <p>(Suggestions always without extra charge articles)</p>	CORE BEECH		
	WILD OAK		
	Lighting per switch (S-LS)		
	Lighting per radio (S-LF)		
	<p>Suggestion (ill.) compromises:</p> <ul style="list-style-type: none"> 1x Cabinet 71, 1 Door, left 1x Lowboard 141, 2 Drawers 1x Sideboard 141, 2 Doors 1x TV-Panel 141 with glass media board 1x Wall panel 141 with glass shelf 1x Suspended element 141, 1 Hatch downwards 		

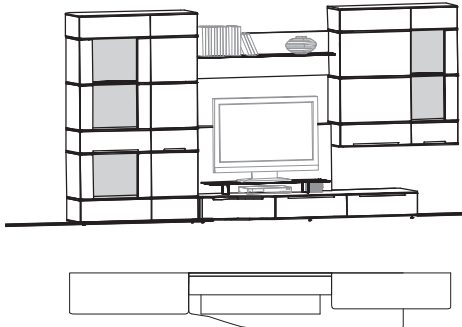
<p>SUGGESTION 445 W/D/H 376,4 / 55,1 / 198 cm</p>  <p>(Suggestions always without extra charge articles)</p>	CORE BEECH		
	WILD OAK		
	Lighting per switch (S-LS)		
	Lighting per radio (S-LF)		
	<p>Suggestion (ill.) compromises:</p> <ul style="list-style-type: none"> 1x Cabinet 118, 2 Doors, left 1x Lowboard deepened 212, 3 Drawers, right 1x TV-Panel 141 with glass media board 1x Wall panel 141 with glass shelf 1x Suspended element 118, 2 Doors, right 		

SALES AND SHIPMENT TERMS AND CONDITIONS

1. General

1.1. The terms and conditions of sale and shipment as detailed below are valid for all business relationships (such as purchasing agreements, contracts of work and labour, fitting agreements, etc.) between VOGLAUER MOBELWERK Gschwandtner & Zwilling GmbH & Co KG, hereinafter referred to as VOGLAUER, and its customers. Customers accept these terms as binding upon them by placing an order or closing a contract with VOGLAUER. Deviating, conflicting or amending General Terms, whether known to VOGLAUER or not, cannot become part of any contract with VOGLAUER except by express written acceptance. Inasmuch as conditions deviating from these terms and conditions of sale and shipment are agreed to in writing as part of a contract, the stipulations of the contract have priority.

1.2. VOGLAUER closes contracts strictly only with registered companies. Should in exceptional cases a customer be a consumer in the sense of consumer protection laws, such customers have the obligation to notify VOGLAUER of that fact. Otherwise, such customers will be held liable. These terms and conditions of sale and shipment will be valid for business with consumers only as far as they are in compliance with imperative stipulations of consumer protection laws.

2. Proposal, Prices

2.1. All prices quoted by VOGLAUER in proposals and price lists are non-binding and net prices except if and where it is clearly indicated that VAT is included. Prices quoted by VOGLAUER are free buyer's address, fitting excluded. VAT will be calculated separately on the basis of the legal provisions valid on the day of delivery or performance of services. VOGLAUER reserves the right to perform technical and other changes within reason. Purchase orders without prices will be processed using the applicable list prices valid the day of arrival of the order.

2.2. If goods or services are delivered later than the agreed date for reasons other than late delivery culpably caused by VOGLAUER, VOGLAUER has the right to raise the prices accordingly. Such price correction will take into account changes of labour costs according to collective treaties and actual costs for performance such as costs of material, energy, transport, financing of external services, etc. between agreed and actual delivery dates.

2.3. Export deliveries will always be charged and payable in Euros. In cases where payment is expressly agreed in a different currency, invoicing will be on the basis of the exchange rate valid on the date of order acknowledgement by VOGLAUER. For this calculation, only exchange rates calculated by Austrian banks will be relevant.

3. Order Acceptance, Subject Matter of Orders

3.1. Purchase orders issued to VOGLAUER will result in a contractual relationship only by written order acknowledgement or delivery of goods or of an invoice by VOGLAUER. Customers have the obligation to provide comprehensive and correct documentation required for the production of the goods (measurements, blueprints, etc.) with the purchase order. Additional costs possibly inflicted by deviation of the actual situation from the documents or blueprints provided by customers as well as additional costs resulting from late provision of such documents will be carried by the customer. Changes to accepted orders will only be possible by written consent.

3.2. If at the time of order placement the ordered goods are not fully specified in all detail (especially technically), a preliminary order acknowledgement will be issued. Customers have the obligation to deliver further detail (actual measurements, etc.) in such time as to allow delivery on time. Upon delivery of the details, a final order acknowledgement will be issued which determines the subject matter of the contract in a binding fashion unless customers send their dissent in writing immediately. If so, the delivery contract will remain valid as by the preliminary order acknowledgement. In case of changes to an order communicated after a preliminary order acknowledgement has been issued, the prices will be adapted to a possibly precursory estimate.

4. Shipment, Delivery

4.1. Unless agreed otherwise, delivery will be free customer's address. Transport insurance will be closed only if expressly requested by the customer. Costs arising from this will be carried by the customer. Unless agreed otherwise in writing, peril of price will be transferred to the customer at the time of shipment of the goods, or in case of late acceptance by the customer, at the time of readiness for shipment by VOGLAUER.

4.2. Unless agreed otherwise in writing, the choice of the place of shipment and the way and means of transport is in VOGLAUER's best discretion, without acceptance of any liability for cheapest or fastest transport. Delivery dates will in any event be non-binding unless expressly agreed to the contrary.

4.3. As a matter of principle, the agreed delivery periods are counted from the date of order acknowledgement. If VOGLAUER is at that time (start of lead time) not in possession of the documentation required for production such as especially actual room measurements, lead time starts at the date of receipt by VOGLAUER of the last document required. Customers have the obligation to provide such documentation in a timely manner. Delivery dates (lead times) will be extended by fitting delays not caused by VOGLAUER. In case a down payment is to be made by the customer, the lead-time will not be counted before the day of its receipt by VOGLAUER.

4.4. If acceptance of the delivered goods by the customer is delayed, whether culpably or otherwise, VOGLAUER has the right to ask a storage charge to an amount customary in the place; Furthermore, VOGLAUER has the right to withdraw from the delivery contract, upon which the customer has to pay the difference between the agreed price and the expectable revenue from realisation of the deliverable goods. In case of included fitting, customers have the obligation to accept the contractual items immediately after completion in a visit. If acceptance is denied, the purchased goods are deemed accepted.

4.5. In case that VOGLAUER fails to meet delivery dates by more than 3 weeks, customers have the right to withdraw from the contract after a reasonable period of grace. If such delay is due to operational reasons VOGLAUER cannot prevent with due diligence of a scrupulous merchant (especially strike, disruption, raw material shortage, etc.), customers will be entitled to withdraw from the contract after a two-month delay after a reasonable period of grace.

5. Withdrawal from Contract

5.1. If a customer fails to fulfil contractual obligations in full or in part, VOGLAUER has the right to withdraw from the contract. The right to withdraw from the contract can be declared for only part(s) of the goods to be delivered. In such cases, VOGLAUER has the obligation to deliver the part of the shipment which is not affected by the withdrawal and customer has the obligation to make payment for that part.

5.2. If VOGLAUER withdraws from a contract for reasons for which the customer is answerable without necessarily being culpable, or if customer withdraws from a contract without being entitled to do so, customer has the obligation to cover the costs of preparatory efforts by VOGLAUER (material purchased, special services, labour expenditure, etc.). VOGLAUER has the choice between the right to charge a lump sum of 25 % of the total amount of the contract without provision of specific evidence for individual efforts. Custom designs already produced by VOGLAUER must be paid for in full minus fitting and shipment costs.

6. Fitting

6.1. In cases where fitting is part of the agreement, customer has the obligation to provide for orderly vehicle access all the way to the rooms to be furnished. Where means of transportation such as cranes and lifts exist, these will be provided for use by VOGLAUER or its subcontractors free of charge.

6.2. Customer accepts liability for storage of the delivered goods on the construction site. This specifically includes theft-protected and dry storage on the construction site.

6.3. Customer will make all necessary provisions so that fitting can be performed without delay; specifically that assembly fitters not be hampered by other craftspeople. Also, the fitting areas of the rooms to be furnished must be heated, clean and sufficiently lighted where required and electric power is to be provided. Costs for electricity and water will be carried by the customer. Carpeted floors must be made slippery-proof and sufficiently covered to prevent soiling and damage by the customer.

6.4. If fitting includes connections with objects owned by the customer or third parties (e.g. Fastening to walls by drilling or chiselling), customer will warn VOGLAUER of perilous locations prior to the commencement of such work, specifically the exact location of electric cables, gas and water pipes and other supply systems will be communicated.

6.5. VOGLAUER has no obligation to inspect the properties of walls or objects to which VOGLAUER parts will be connected. Customer, on the other hand, has the obligation to notify VOGLAUER of properties of walls or objects possibly impairing simple and problem-free fitting. Any additional work and expense resulting from unpredicted properties of walls and objects will be charged to the customer.

6.6. Additional costs for overtime authorized and fitting delays caused by the customer as well as work not included in the order acknowledgement or work caused by inadequate environment will be charged separately. This will also be the case if VOGLAUER has offered fitting for a lump sum or for free as a discount.

6.7. Customer will at their own costs take care of cleaning of the rooms after fitting. Lack of contractual stipulations to the contrary, fitting services offered by VOGLAUER do not include fitting and connecting of electric equipment of any kind and lighting appliances. Unless agreed otherwise, such work is to be performed by authorized craftsmen at customer's own expense. Packaging material will be disposed of by the customer at his or her own expense.

7. Notification of Defects

Upon delivery, customers must immediately inspect the goods for possible defects. Incomplete or wrong shipments as well as complaints for recognisable defects will be directed to VOGLAUER in writing immediately upon receipt of the goods, non-recognisable defects immediately upon their discovery. The notification must indicate clearly the kind and extent of the alleged defect. In case of late notification of defects and errors, the shipment will be considered approved, in which case warranty claims are ruled out.

8. Warranty

VOGLAUER provides warranty for the delivered goods for a period of one year from the shipment date. For electric implements and lighting appliances delivered by VOGLAUER, the warranty period will be six months. In cases of justified and timely notification of defects, VOGLAUER will, reasonably taking into account customer's interest, provide warranty by improvement, price reduction or replacement (exchange) or take back the goods refunding the purchase price. The choice of the warranty method is VOGLAUER's. If VOGLAUER fails to meet warranty obligations within reasonable time, customer has the right to a reasonable price reduction or to withdraw from the contract. Activities started by VOGLAUER due to unjustified notifications of defect are considered purchase orders, and customers have the obligation to pay for the services rendered thereunder.

Excluded from the warranty are specifically:

- Goods provided by the customer;
- Damages resulting from deficiencies of the environment (e.g. faulty walls, construction material moisture, construction deficiencies, etc.);
- Compatibility of material used by VOGLAUER with other parts and properties of the rooms to furnish, such as other furnishing, lighting colours, heating, etc.;
- Deformation and crevices of massive wood used;
- Function of the delivered goods and suitability of the material used if the customer has been made by the customer or his agent (e.g. architect);
- Minor deviations of hues and surface or veneer structures of the delivered goods;

9. Exclusions from Liability

9.1. VOGLAUER can be held liable for damages outside of the applicability of the product liability law only in cases of intent or gross negligence. Liability for slight negligence is foreclosed, as is compensation for consequential damage and financial loss, failure to realise savings or profit, losses from interest and damages from third party claims against the customer.

9.2. Within the applicability of the product liability law, VOGLAUER will be liable for personal damage and for material damage suffered by consumers. VOGLAUER will not be liable for material damage suffered by companies. Regress by the customer as defined in § 933b ABGB (Austrian General Law) is excluded. Claims for damages are in any event limited to a three-year period, counted from shipment.

9.3. The parties to a contract also mutually renounce all claims for any damages covered by an insurance held by the damaged party. This renunciation will not extend to damages inflicted by intent or gross negligence or if the insurer would be exempt from indemnification as a consequence of such renunciation.

9.4. Locking mechanisms or safe deposits provided by VOGLAUER will not constitute theft or break-in protection so that claims for damages resulting from these are excluded. A possibly required anti-theft device will therefore be acquired by the customer at his or her own cost and risk; VOGLAUER will not be held liable for locked items.

10. Payment

10.1. Invoices for the delivery of goods will be sent by email and are payable according to the stipulations of the individual contract. Unless stipulated otherwise, the customer will pay one third of the total amount quoted in the order acknowledgement as a down payment promptly upon order placement, one third two weeks prior to readiness for shipment and the remaining amount immediately upon receipt of the final invoice without discount. As far as there is no written agreement between the parties to a contract with regards to terms of payment, the amounts invoiced are payable directly upon receipt of the invoices without discounts. Bills of exchange or cheques will be accepted only on the grounds of separate written agreement and solely as payment. Discount and exchange expenses will be payable immediately by the customer. The customer recognises that VOGLAUER field staff are not entitled to collect payment.

10.2. In case of delayed payment, interest for delay amounting to 8 % above the then current base-lending rate will be charged. Set-off by the customer is ruled out except with receivables accepted in writing by VOGLAUER or ascertained in a legally binding manner.

10.3. If a customer cannot continue orderly business operations or forced sale of collaterals is in progress, if an act of protest is ongoing or delay or stop of payments is prevailing or if the customer has filed in or out of courts for a settlement system or bankruptcy has been declared, whether successful or not, VOGLAUER has the right to declare all outstanding bills from the business relationship due immediately, even if bills of exchange or cheques have been accepted or payment by instalments has been agreed. This also applies if and when the customer is late with payment or other circumstances indicate towards a questionable creditability. Furthermore, VOGLAUER has in the above-mentioned cases the right to demand advance payment or securities, realise securities provided or withdraw from the contract, claiming damages for default of performance.

10.4. Customers do not have the right to withhold payment due to alleged deficiencies, except if such deficiencies and the withholdable amounts have been accepted in writing by VOGLAUER or ascertained by a legal court. Any cession of customer receivables against VOGLAUER to third parties as well as any cession of rights and obligations of the closed contract is prohibited without prior written consent by VOGLAUER.

11. Reservation of Property Rights

11.1. The goods delivered remain the sole property of VOGLAUER until fulfilment of all obligations of the customer, specifically full payment of the purchase price including all side costs and interest, dues, fees, etc

11.2. Goods delivered for a particular building project, even if ordered, delivered and invoiced in tranches, are considered one coherent order. In such cases the reservation of property rights to all goods delivered will expire only when all payments resulting from the contracts therein have been made in full.

11.3. The customer has the right to sell goods delivered under this reservation of property rights only if they are dedicated goods for resale or after the reservation of property rights has expired or VOGLAUER expressly authorizes such sale. In case of resale of goods, the customer will cede all claims resulting from such sale to VOGLAUER. The customer has the obligation to make such cession recognizable by corresponding entries in his or her books and to disclose to VOGLAUER upon request the names of the debtors as well as to precisely specify the ceased receivables. The cession will be accepted by VOGLAUER. Any dues or taxes related to such cession are to be carried by the customer, who will indemnify VOGLAUER of claims resulting thereof. VOGLAUER retains the right to disclose the cession and to realise the receivables ceased directly.

11.4. The customer has the obligation to sufficiently cover the reserved goods by insurance against common risks such as elementary events and to provide proof of such cover to VOGLAUER upon request. The customer hereby ceases given insurance claims to VOGLAUER. The customer also has the obligation to store the goods according to instructions given by VOGLAUER and to the state of the art. The customer has the obligation to tend to the goods during the reservation of property rights.

11.5. The customer will immediately notify VOGLAUER of access to the goods under reservation of VOGLAUER property rights by third parties (execution or listing for execution, other court orders or enactments). The customer will support and assist VOGLAUER in legal attempts to protect VOGLAUER's rights to the property and carry all associated costs if the customer has inflicted the threat to reserved VOGLAUER property.

11.6. In case of connection or mingling of reserved VOGLAUER property with other goods, VOGLAUER will gain joint ownership in the resulting goods proportionally to the value of the reserved property with respect to the value of the other goods at the time of connection or mingling. In case of sale of the resulting matter, the customer will cede the aliquot sales price in the sense of the stipulation above to VOGLAUER.

12. Intellectual Property

Trade marks, representations and the associated sketches, plans and descriptions are the intellectual property of VOGLAUER and must not be copied or disclosed to third parties without prior written consent by VOGLAUER.

13. Advertising

It is accepted that objects furnished by VOGLAUER may be used by VOGLAUER for purposes of advertising (reference lists, brochures, press releases, etc.) quoting customer names and using pictures of the furnished objects. The customer grants VOGLAUER the right to take pictures of the furnished objects.

14. Force Majeure

Events of force majeure affecting VOGLAUER or any of VOGLAUER's suppliers constitute the right for VOGLAUER to suspend deliveries for the duration of the hampering circumstances plus a reasonable lead-time without such suspension constituting a delay or the right for customers to fully or partially withdraw from the contract.

Events of force majeure are, among other things: All effects of the forces of nature such as earthquake, lightning, frost, storm, flood; furthermore, war, legal action, enactments by local authorities, detention, transport disruption, export, import or transit bans, international payment restrictions, raw material shortage and power loss; furthermore, operational disruptions such as explosion, fire, strike, sabotage and all other events which could not be prevented other than by unreasonably high costs or means not economically justifiable.

15. Data Privacy Assent

The customer expressly agrees that collection, processing and use of personal data provided by the customer be used by VOGLAUER for marketing purposes by installation of a customer data base and related activities. This assent specifically includes information transfer for purposes of advertising by fax, letter, email or any other method. This assent can be withdrawn by customers at all times with immediate effect for the future.

16. Final Provisions

16.1. All contracts closed by and with VOGLAUER as well as these terms and conditions are governed exclusively by Austrian law with the exclusion of the delegation norms and the UN convention on contract for the international sale of goods. All disputes arising directly or indirectly from contracts with VOGLAUER will be regulated at the appropriate court in the city of Salzburg, Austria. Place of performance for delivery and payment will be the principal office of VOGLAUER.

16.2. In case one or more of the stipulations herein or in a contract become invalid in full or in part, validity of the remaining stipulations will remain untouched. Fully or partly invalid stipulations will be considered replaced by provisions whose economical success approximates closest the original stipulation(s).

16.3. All changes or amendments of contracts between VOGLAUER and customers must be in writing, including the agreement to waive this stipulation. All declarations by VOGLAUER will only be legally binding if they are issued in writing by staff of the VOGLAUER principal office at Abtenau, Austria.

Vsoft
Die Natur sanft erleben

CUBIC SHAPES WITH SOFT EASINESS

The furniture of the V-Soft line for dining and living areas emanate elegance and well being in every living space with the softly rounded solid wood components.



Suggestion SV411 | Wild oak brushed and oiled

Design. Nature. Handcraft.



A commitment to nature and quality for over 80 years.

Innovative with consideration of the green and social environment



Ecolabels for

- Raw material and energy consumption
- Tested ingredients
- Emissions
- Disposal / recycling
- Packaging
- Power generation through in-house hydropower

Own hydropower



- Power generation through in-house hydropower

60 % of the energy consumption in production is covered by our own hydropower!

Energy/Recycling



- Thermal utilisation of 95 % of the wood waste
- Recycling of all water-based lacquers and wood strippers
- Energy comes from renewable energy sources
- Conscious waiver of air conditioning systems due to special night-ventilation system

Social responsibility



- Voglauer Academy – Training of the employees
- Free Shuttle-Service for employees
- Company cafeteria
- Support of public safety organisations



Wood from sustaining sources

Furniture – pure and genuine

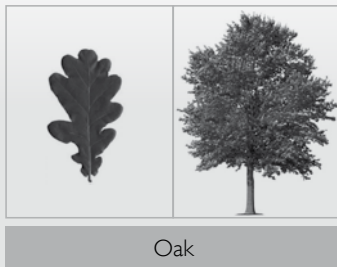

Oak

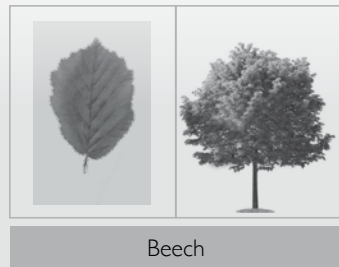

Beech

WOODEN FURNITURE for a pleasant atmosphere

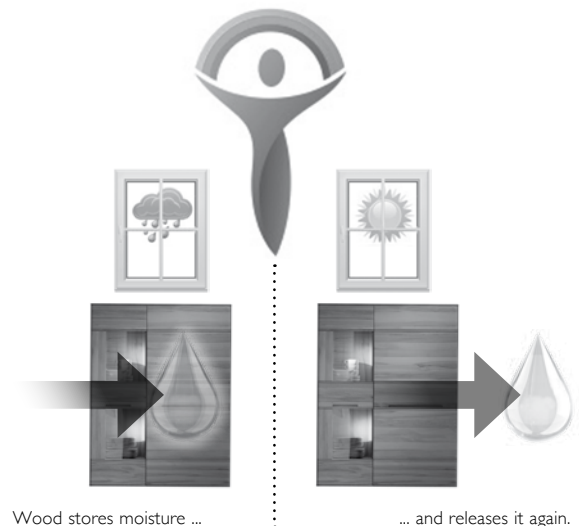

Wood stores moisture ...

... and releases it again.

VOGLAUER FURNITURE LINES



V-Solid / NEW 2015

- Dining
- Living



V-Alpin

- Dining
- Living
- Hall



V-Montana

- Dining
- Living
- Hall



V-Loft

- Dining
- Living



V-Vita

- Dining
- Living
- Hall



V-Soft

- Dining
- Living



V-Pur / NEUHEIT 2015

- Sleeping



V-Rivera

- Sleeping



V-Linea

- Sleeping

Request desired folders either by telephone or on our homepage.
It will be a pleasure for us to send them to you for free.

Voglauer traders:

You would like further information about our business or product lines? If so, please visit us online www.voglauer.com.



Follow us on Facebook!
Regular News from VOGLAUER.

Voglauer Möbelwerk Gschwandtner & Zwilling GmbH & Co KG
A-5441 Abtenau / Salzburger Land | Tel. +43 6243 2700-0 | Fax DW-210
Email: office@voglauer.com | www.voglauer.com