

**VOGLAUER**

**U solid**



inkl. juraschlamm

# MODELS REGISTER

(valide from January 2015)

Please always indicate the following specifications:

**MODEL:** V-Solid **SD**

**TYPE OF WOOD:**



Black rustic wild oak ER

**Accent** (selected parts)



Beam Design, massive hacked  
(Structural and color deviation acc. to main wood)

**GLASS/FRONTEND**

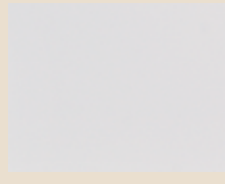

optiwhite O

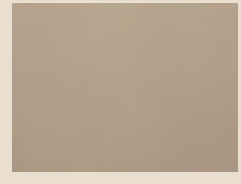

juraschlamm J

**LODEN fabric for upholstery** (indicate loden number and description)



grauweiß MG



basaltgrau MB



tundrabraun MT

**LIGHTING**



Lighting per switch LS



Lighting per remote LF

**LEDER (fabric for upholstery)** (indicate leather number and description)



sahne LW



ziegelrot LY



burgundy LX

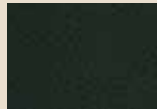

army green LZ



cognac LV

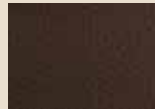

café LU

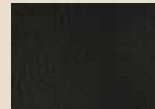

testa di moro LT



schwarz LS



kiesel LK



coco LO



stone LM



cenere LP

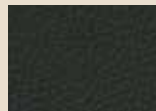

anthrazit LN

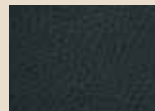

oceano LL



reinweiß LR

The colour samples are not suitable as color samples.

**REFERENCE NUMBER:**

Please indicate each article by its reference number. **Attention: Indicate article-specific complements!**

**Ordering example:**

- DLH17A-L-0 ER** Lowboard 176/67 with accent, 4 hatches, make left, frontend optiwhite, Black rustic wild oak ER W/D/H 176/55,8/67 cm
- D-OL17** Ex. ch. glass panel
- D-S17** Ex. ch. 2 drawers 112 + 64 instead of hatch
- D-K** Ex. ch. Cable management
- DV64-L-0-ER** Cabinet 64, 1 door, door stop left, frontend optiwhite, Black rustic wild oak ER, W/D/H 64/42,7/195,4 cm
- D-LS4** Ex. ch. Lighting per switch
- SEGP64-MG-LO-ER** Upholstered chair 64, fabric back MG Loden grauweiß, fabric seat LO leather coco, Black rustic wild oak ER, W/D/H 49,5/ 60/ 87,5

**ORDER MANAGEMENT AND TECHNICAL SUPPORT: Fax Nr.: +43 (0) 6243 2700 - 359**



**Daniel WALLINGER**  
Tel. +43 (0) 6243 2700-355  
daniel.wallinger@voglauer.com



**Andreas FEISER**  
Tel. +43 (0) 6243 2700-352  
andreas.feiser@voglauer.com



**Theresa WINTERSTELLER**  
Tel. +43 (0) 6243 2700-377  
theresa.wintersteller@voglauer.com



**Michael RESCHREITER**  
Tel. +43 (0) 6243 2700-357  
michael.reschreiter@voglauer.com



**Andrea GSENGER**  
Tel. +43 (0) 6243 2700-450  
andrea.gsenger@voglauer.com

**DELIVERY DATE INFORMATION: Fax: +43 (0) 6243 2700 - 315**

**Delivery:** 5-7 weeks after having obtained commission

Helmut POSCH: helmut.posch@voglauer.com

Johann STEINER: johann.steiner@voglauer.com

**VOGLAUER – CERTIFICATIONS AND AWARDS**



## Structural Design / Loading Capacities:

Corpus:	Corpus parts blockboard veneered with genuine wood		
Fronts and Cover Panels:	Blockboard veneered with genuine wood edged in cross-grained wood, colorglass, resp. toughened safety glass		
Accent:	beam-Design, solid, hackd oak at exclusive elements (structur and colour variate, according to normal wood)		
Panels:	Blockboard veneered with genuine wood and edged in cross-graned wood (14mm), optional (Lowboard) with colorglas (8mm)		
Shelf rows:	Wooden shelf rows behind wooden doors, Transparent front glasses and glass boards		
Drawers:	Dovetailed solid wood drawers (beech) with covered, smooth-running self-closing drawer runner		
Front profile / Handles:	Opens when tipped		
Tables:	all solid wood, coffe-table-glass panels in toughened safety glass (8mm colorglass)		
Benches:	Framework solid oakwood, seat and backrest upholstered with cattle hide napa leather or loden		
<b>Loading capacity:</b>	Glass shelf rows 6 mm:	max. 5 kg	Drawers up to 80 cm wide: max. 10 kg
	Wooden shelf rows:	max. 20 kg	Drawers beyond 80 cm wide: max. 25 kg

## LED-Lighting (optional):

All lighting systems are installed and wired securely in(to) the furniture by VOGLAUER. Every illuminated element has its own controller and/or transformer and a power cable (approx. 2,5m) with EURO-plug. The lamps (illuminant) cannot be replaced in the fixtures.

Optional lighting:

- with internal light switch
- with remote-controlled radio circuit and dimmer (every element comes with its own handheld transmitter - subsequently several lighting systems can be adapted to one single transmitter)

Energy efficiency grade: A - A++

Performance/Consumption: LED-Spot: 2 Watt, LED-Stripe: 4,8 Watt

According to the linked up elements, with the beam-board, normally the long board is equipped with the switch or the remote-control, the lightings of the neighboured elements are, in this case, without switch (LO). (Electric supply by the long beam-board)

## Wood Composites - Indoor Climate:

Despite accurate processing wood is a living raw material; standing in reaction with air humidity and adapts to climatical conditions. Different colours, structures, small shakes, slight warping or open knots can be unavoidable consequences. An ideal indoor climate for wooden furniture would be approximately 18-23° C and 44-55 % air humidity. In order to avoid shakes and warpings, solid wood furniture should undergo low variability of the climate.

## Oiled Surfaces:

All Voglauer surfaces equate to organic products concerning their environmental compatibility and ecology. The oiled surface is breathable and improves the indoor climate. The surface is antistatic, i.e. dust- and dirt-repellent.

**Maintenance of oiled surfaces:** To maintain the oiled Voglauer furniture's worth, it is advisable to oil it more or less every 6-8 months. Apply the Voglauer maintenance set (see: additional - „Maintenance oil“) thinly with a smooth, not fraying cloth and spread it evenly in fibre direction. Afterwards polish it with a dry cotton cloth. The surface will shine silk and velvety.

## Upholstery - Loden - Leather:

- Loden of 100% Merino wool (highest quality and finest sheep's wool)
- Heavy-weight soft cattle hide napa leather with expressive grain.
- Each skin is unique and has undergone many production steps, hence slight colour differences are inevitable. This must be taken into account especially when comparing original furniture to their samples.
- Wrinkling is a natural procedure and therefore no decrease in quality. It occurs as a consequence of the leather's using or stretching.

## Important Planning Advices:





- Check out constructional conditions, obstructions, measures and resilience at determination of material requirements to ensure a performance free of defects.
- Check out electrical conditions for connections and engineering (freely suspended lighting systems require cable ducts on or under plaster). Every illuminated element has its own power cable (approx. 2,5 m) with EURO-plug. In carcass furniture power connection for lighting (power point, cable exit) can be entirely located behind the rear panel (distance to wall approx. 23 mm).
- The door hinges are nickel-plated and 3-dimensional adjustable. Essential for the door's exact matching is to place the furniture on a flat bottom - in case of unevenness furniture items can be compensated with the included furniture wedges. All elements with doors have to be mounted with distance to the wall, because the doors open over the side of the corpus (knocked open) - according to the sketch.



## Installation of the Furniture:

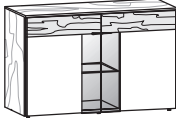
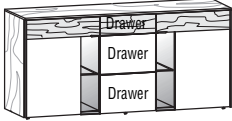
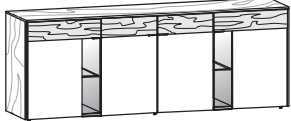
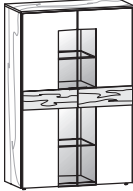
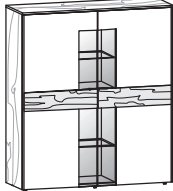





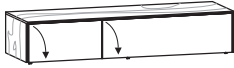

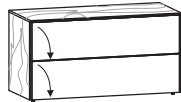
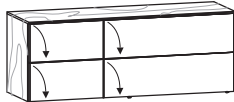
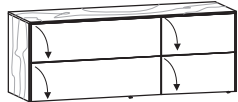
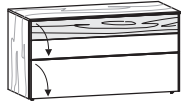
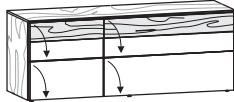
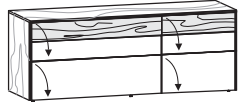

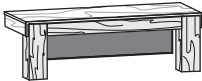
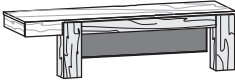
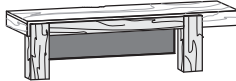
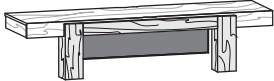

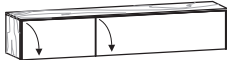
Due to the big doors and full-opening drawers, furniture's standing on the ground has to be attached to the wall, to pretend it from tilting over. VOGLAUER includes the compatible installation-equipment for firm masonry. For drywalls / metal-stud walls the technician has to get compatible dowels and screws by himself. VOGLAUER don't assume any liability for the installation. Every furniture from Voglauer is assembled and performed individually. Some bulky goods are delivered in separate pieces. There are mounting instructions for not assembled goods (e.g. media elements)

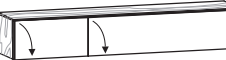
## VOGLAUER Furniture Quality Certificate:

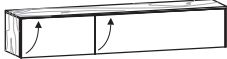

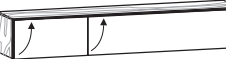







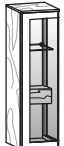



Every consignment comes with a VOGLAUER quality certificate (Online Download: [www.voglauer.com](http://www.voglauer.com)). VOGLAUER do not assume any liability for not conforming to care and maintenance instructions or misuse.



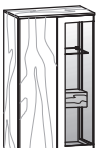
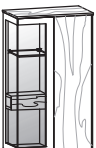

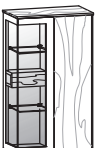

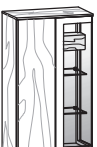



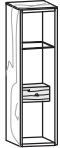

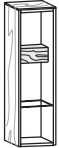

	<p>Upper front beam-design (accent) left and right, 1 shelf each in the middle 1 glass-shelf</p>  <p>W/D/H 128,2/ 52,1/ 83,4 cm</p>	<p>Upper front beam-design (accent) left and right, 1 shelf each glassparts, 1 glass-shelf each</p>  <p>W/D/H 176,2/ 52,1/ 83,4 cm</p>	<p>Upper front beam-design (accent) left and right, 1 shelf each glassparts, 1 glass-shelf each in the middle 1 shelf</p>  <p>W/D/H 224,2/ 52,1/ 83,4 cm</p>			
Description	Sideboard 128, 2 doors		Sideboard 176, 2 Doors, 3 drawers		Sideboard 224, 4 doors	
Glass/ front side	optiwhite	juraschlamm	optiwhite	juraschlamm	optiwhite	juraschlamm
Lighting per switch						
Extra Charge lighting - remote and dimmer						
	<p>Fibre belt beam-design (accent) left and right, 3 shelves each in the middle: 1 fix shelf, 2 glass-shelfs</p>  <p>W/D/H 96,2/ 42,8/ 147,4 cm</p>	<p>Fibre belt beam-design (accent) left and right, 3 shelves each in the middle: 1 fix shelf, 2 glass-shelfs</p>  <p>W/D/H 128,2/ 42,8/ 147,4 cm</p>				
Description	Highboard 96, 2 doors		Highboard 128, 2 doors			
Glass/ front side	optiwhite	juraschlamm	optiwhite	juraschlamm		
Lighting per switch						
Extra Charge lighting - remote and dimmer						
	<p>Fibre belt beam-design (accent) right outer face (Glass) + beam-design (accent) top 1 fix, persistant shelf left 4 shelves right 1 fix shelves, 2 glass-shelfs</p>  <p>W/D/H 65,1/ 42,8/ 195,4 cm</p>	<p>Fibre belt beam-design (accent) left outer face (Glass) + beam-design (accent) top 1 fix, persistant shelf left 1 fix shelves, 2 glass-shelfs right 4 shelves</p>  <p>W/D/H 65,1/ 42,8/ 195,4 cm</p>	<p>Fibre belt beam-design (accent) top 1 fix, persistant shelf left and right 4 shelves, each in the middle 1fix shelf, 2 glass-shelfs</p>  <p>W/D/H 96,2/ 42,8/ 195,4 cm</p>			
Description	Cabinet 64, 1 door, door stop left	Cabinet 64, 1 door, door stop right	Cabinet 96, 2 doors			
Glass/ front side	optiwhite	juraschlamm	optiwhite	juraschlamm	optiwhite	juraschlamm
Lighting per switch						
Extra Charge lighting - remote and dimmer						

Rear panel is shorted for the cables duct (cut-out 16 cm)						
	 <p>W/D/H 128,2/55,8/35 cm</p>		 <p>W/D/H 176,2/55,8/35 cm</p>		 <p>W/D/H 176,2/55,8/35 cm</p>	
Description	Lowboard 128/35, 1 glass-hatch		Lowboard 176/35, 2 glass-hatches make left		Lowboard 176/35, 2 glass-hatches, make right	
Glass/ front side	optiwhite	juraschlamm	optiwhite	juraschlamm	optiwhite	juraschlamm
Ex. ch. glass panel						
Ex. ch. drawer 128 instead of hatch						
Ex. ch. drawer 64 instead of hatch						
Ex. ch. drawer 112 instead of hatch						
Ex. ch. cable management - hatch incl. plug connector						
for cable duct distance between rear panel and wall: 8,4 cm						
	 <p>W/D/H 128,2/55,8/67 cm</p>		 <p>W/D/H 176,2/55,8/67 cm</p>		 <p>W/D/H 176,2/55,8/67 cm</p>	
Description	Lowboard 128/67, 2 glass-hatches		Lowboard 176/67, 4 glass-hatches, make left		Lowboard 176/67, 4 glass-hatches, make right	
Glass/ front side	optiwhite	juraschlamm	optiwhite	juraschlamm	optiwhite	juraschlamm
Ex. ch. glass panel						
Ex. ch. drawer 128 instead of hatch	Due to order: mention drawer-installation <b>TOP</b> or <b>BOTTOM!</b>					
Ex. ch. 2 drawers 112+64 instead of hatch						
Ex. ch. cable management - hatch incl. plug connector						
for cable duct distance between rear panel and wall: 8,4 cm						
	 <p>W/D/H 128,2/55,8/67 cm</p>		 <p>W/D/H 176,2/55,8/67 cm</p>		 <p>W/D/H 176,2/55,8/67 cm</p>	
Description	Lowboard 128/67 with accent, 2 hatches		Lowboard 176/67 with accent, 4 hatches, make left		Lowboard 176/67 with accent, 4 hatches, make right	
Glass/ front side	optiwhite	juraschlamm	optiwhite	juraschlamm	optiwhite	juraschlamm
Ex. ch. glass panel						
Ex. ch. drawer 128 instead of hatch	Due to order: mention drawer-installation <b>Top</b> or <b>BOTTOM!</b>					
Ex. ch. 2 drawers 112+64 instead of hatch						
Ex. ch. cable management - hatch incl. plug connector						









<p>Media-hatch with acoustic fabric, plug connector, for hardware-installation respectively wiring, panel and front are extendible to the fore Frontend and bed-plate in beam-design (accent) - wall-fastening required!</p>											
 <p>W/D/H 150/57,8/48 cm</p>		 <p>W/D/H 180/57,8/48 cm</p>		 <p>W/D/H 180/57,8/48 cm</p>		 <p>W/D/H 210/57,8/48 cm</p>					
Description		Mediaelement 150 cm		Mediaelement 180, make left		Mediaelement 180, make right		Mediaelement 210 cm			
Extr. charge lateral drawer				only available left		only available right		Mention, if installation <b>left, right or both-sided</b>			
Ex. ch. built in Infrarot-Repeater (receiver in centre of beam)											
Total resilience max. 70 kg		 <p>W/D/H 128,2/38,1/33,4 cm</p>		 <p>W/D/H 176,2/38,1/33,4 cm</p>		 <p>W/D/H 176,2/38,1/33,4 cm</p>		 <p>W/D/H 192,2/38,1/33,4 cm</p>		 <p>W/D/H 192,2/38,1/33,4 cm</p>	
Description		Suspended element 128, 1 glass-hatch downwards		Suspended element 176, 2 glass-hatches downwards, make left		Suspended element 176, 2 glass-hatches downwards, make right		Suspended element 192, 2 glass-hatches downwards, make left		Suspended element 192, 2 glass-hatches downwards, make right	
Glass/ front side		optiwhite   juraschlamm		optiwhite   juraschlamm		optiwhite   juraschlamm		optiwhite   juraschlamm		optiwhite   juraschlamm	
Lighting per switch											
Ex. ch. lighting - remote and dimmer											
Total resilience max. 70 kg		 <p>W/D/H 128,2/38,1/33,4 cm</p>		 <p>W/D/H 176,2/38,1/33,4 cm</p>		 <p>W/D/H 176,2/38,1/33,4 cm</p>		 <p>W/D/H 192,2/38,1/33,4 cm</p>		 <p>W/D/H 192,2/38,1/33,4 cm</p>	
Description		Suspended element 128, 1 glass-hatch upwards		Suspended element 176, 2 glass-hatches upwards, make left		Suspended element 176, 2 glass-hatches upwards, make right		Suspended element 192, 2 glass-hatches upwards, make left		Suspended element 192, 2 glass-hatches upwards, make right	
Glass/ front side		optiwhite   juraschlamm		optiwhite   juraschlamm		optiwhite   juraschlamm		optiwhite   juraschlamm		optiwhite   juraschlamm	
Lighting per switch											
Ex. ch. lighting - remote and dimmer											
Total resilience max. 70 kg		<p>2 shelves</p>  <p>W/D/H 64,2/37,8/97,4 cm</p>				<p>2 shelves</p>  <p>W/D/H 48,2/37,8/113,4 cm</p>					
Description		Suspended element 64/97, 1 wooden door, door stop left		Suspended element 64/97, 1 wooden door, door stop right		Suspended element 48/113, 1 wooden door, door stop left		Suspended element 48/113, 1 wooden door, door stop right			



Total resilience max 50 kg	 right outer face glass 1 glass-shelf 1 beam-board (accent)	 left outer face glass 1 glass-shelf 1 beam-board (accent)	 right outer face glass 2 glass-shelf 1 beam-board (accent)	 left outer face glass 2 glass-shelf 1 beam-board (accent)
	W/D/H 32,8/37,8/113,4 cm		W/D/H 32,8/37,8/113,4 cm	
Description	Suspended glass cabinets 32/113, 1 door, door stop left		Suspended glass cabinets 32/113, 1 door, door stop right	
Front/Seitenglas	optiwhite	juraschlamm	optiwhite	juraschlamm
Lighting per switch				
Extra charge lighting - remote and dimmer				
Ex. ch. lightning - without switch <span style="float: right;">Power-supply and switching with parallel-element!</span>				
Total resilience max 50 kg	 right outer face glass 1 glass-shelf 1 beam-board (accent)	 left outer face glass 1 glass-shelf 1 beam-board (accent)	 right outer face glass 2 glass-shelf 1 beam-board (accent)	 left outer face glass 2 glass-shelf 1 beam-board (accent)
	W/D/H 32,8/37,8/113,4 cm		W/D/H 32,8/37,8/113,4 cm	
Description	Suspended glass cabinets 32/113, 1 door, door stop left		Suspended glass cabinets 32/113, 1 door, door stop right	
Front/Seitenglas	optiwhite	juraschlamm	optiwhite	juraschlamm
Lighting per switch				
Extra Charge lighting - remote and dimmer				
Ex. ch. lightning - without switch <span style="float: right;">Power-supply and switching with parallel-element!</span>				
Total resilience max. 70 kg	 right outer face glass le. 2 shelves ri. 1 glass-shelf, 1 beam-board (accent)	 left outer face glass le. 1 glass-shelf, 1 beam-board (accent) ri. 2 shelves	 right outer face glass le. 2 shelves re. 2 glass-shelves, 1 beam-board (accent)	 left outer face glass le. 2 glass-shelves. 1 beam-board (accent) ri. 2 shelves
	W/D/H 64,8/37,8/113,4 cm		W/D/H 64,8/37,8/113,4 cm	
Description	Suspended glass cabinets 64/113, 1 door, door stop left		Suspended glass cabinets 64/113, 1 door, door stop right	
Front/Seitenglas	optiwhite	juraschlamm	optiwhite	juraschlamm
Lighting per switch				
Extra Charge lighting - remote and dimmer				
Ex. ch. lightning - without switch <span style="float: right;">Power-supply and switching with parallel-element!</span>				
Total resilience max. 70 kg	 right outer face glass le. 2 shelves ri. 1 glass-shelf, 1 beam-board (accent)	 left outer face glass le. 1 glass-shelf, 1 beam-board (accent) ri. 2 shelves	 right outer face glass le. 2 shelves ri. 2 glass-shelves, 1 beam-board (accent)	 left outer face glass le. 2 glass-shelves. 1 beam-board (accent) ri. 2 shelves
	W/D/H 64,8/37,8/113,4 cm		W/D/H 64,8/37,8/113,4 cm	
Description	Suspended glass cabinets 64/113, 1 door, door stop left		Suspended glass cabinets 64/113, 1 door, door stop right	
Front/Seitenglas	optiwhite	juraschlamm	optiwhite	juraschlamm
Lighting per switch				
Extra Charge lighting - remote and dimmer				
Ex. ch. lightning - without switch <span style="float: right;">Power-supply and switching with parallel-element!</span>				

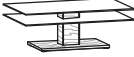

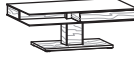
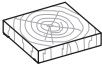
<p>Total resilience max 50 kg</p>	 <p>1 glass-shelf 1 beam-board (accent)</p> <p>W/D/H 32,2/35,3/113,4 cm</p>	 <p>2 glass-shelves 1 beam-board (accent)</p> <p>W/D/H 32,2/35,3/113,4 cm</p>	 <p>1 glass-shelf 1 beam-board (accent)</p> <p>W/D/H 32,2/35,3/113,4 cm</p>	 <p>2 glass-shelves 1 BBeam-board (accent)</p> <p>W/D/H 32,2/35,3/113,4 cm</p>
<p>Description</p>	<p>Suspended rack 32/113, open</p>	<p>Suspended rack 32/113, open</p>	<p>Suspended rack 32/113, open</p>	<p>Suspended rack 32/113, open</p>
<p>Lighting per switch</p>				
<p>Ex. ch. lighting - remote and dimmer</p>				
<p>Ex. ch. lightning - without switch      Power-supply and switching with parrallel-element!</p>				
<p>Total resilience max 10 kg</p>	<p>beam-Board all in beam-design (accent) - solid, hacked oak (Structure- and color-variations, in comparison to normal wood)</p>			
 <p>W/D/H 16/20,6/12 cm</p>	 <p>W/D/H 24/20,6/12 cm</p>	 <p>W/D/H 128/20,6/12 cm</p>	 <p>W/D/H 144/20,6/12 cm</p>	
<p>Description</p>	<p>beam-board 16 cm</p>	<p>beam-board 24 cm</p>	<p>beam-board 128 cm</p>	<p>beam-board 144 cm</p>
<p>Lighting per switch</p>				
<p>Ex. ch. lighting - remote and dimmer</p>				
<p>Ex. ch. lightning - without switch Power-supply and switching with parrallel-element!</p>				
<p>Total resilience max 10 kg</p>	<p>beam-Board all in beam-design (accent) - solid, hacked oak (Structure- and color-variations, according to normal wood)</p>			
 <p>W/D/H 160/20,6/12 cm</p>	 <p>W/D/H 176/20,6/12 cm</p>	 <p>W/D/H 192/20,6/12 cm</p>		
<p>Description</p>	<p>beam-board 160 cm</p>	<p>beam-board 176 cm</p>	<p>beam-board 192 cm</p>	
<p>Lighting per switch</p>				
<p>Ex. ch. lighting - remote and dimmer</p>				
<p>Ex. ch. lightning - without switch Power-supply and switching with parrallel-element!</p>				
<p>Total resilience max 10 kg</p>	<p>Inserted wall board with fitting</p>			
 <p>W/D/H 128/24/3,9 cm</p>	 <p>W/D/H 160/24/3,9 cm</p>	 <p>W/D/H 176/24/3,9 cm</p>	 <p>W/D/H 192/24/3,9 cm</p>	
<p>Description</p>	<p>Inserted wall board 128 cm</p>	<p>Inserted wall board 160 cm</p>	<p>Inserted wall board 176 cm</p>	<p>Inserted wall board 192 cm</p>

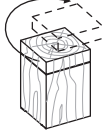
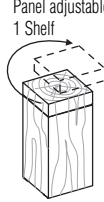
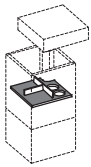
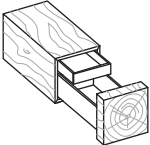
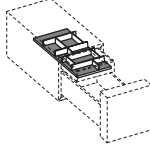



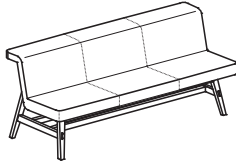
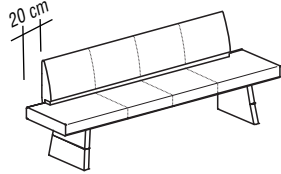

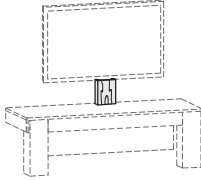

		Coffee Tables 90/90 cm bottom panel and drawer front color glass							
									
		W/D/H 90/90/43 cm	W/D/H 90/90/43 cm	W/D/H 90/90/43 cm	höhenverstellbar 35,5 bis 71,5 cm W/D/H 90/90/35,5 cm				
Description		Coffee table 90/90 cm, without drawers		Coffee table 90/90 cm, with 1 drawer		Coffee table 90/90 cm, with 2 drawers		Coffee table 90/90 cm, height adj., 2 drawers	
Glass panel		optiwhite	juraschlamm	optiwhite	juraschlamm	optiwhite	juraschlamm	optiwhite	juraschlamm
		Coffee Tables 75/120 cm bottom panel and drawer front color glass							
									
		W/D/H 75/120/43 cm	W/D/H 75/120/43 cm	W/D/H 75/120/43 cm					
Description		Coffee table 75/120cm, without drawers		Coffee table 75/120cm, with 1 drawer		Coffee table 75/120cm, with 2 drawers			
Glass panel		optiwhite	juraschlamm	optiwhite	juraschlamm	optiwhite	juraschlamm		
		Panel with end-grain-inlay							
									
		W/D/H 48/48/10 cm	W/D/H 34,4/34,4/34,9 cm	W/D/H 34,4/34,4/52 cm	W/D/H 34,4/34,4/73 cm	Available for articles <b>DK52, DK73</b> W/D/H 30/30/5,5 cm			
Description		Cube 48/48, 10 cm height	Cube 34/34, 35 cm height	Cube 34/34, 52 cm height	Cube 34/34, 73 cm height	variable accessories			
		Drawer-front-end with end-grain-inlay							
									
		W/D/H 34,4/80/34,9 cm	W/D/H 25,9/59,3/5,5 cm	Available for top drawer by <b>DK80</b>					
Description		Cube 80/34, 35 cm height, 2 drawers		variable accessories					

<p>Panel solid 26 mm</p> <p>~ 48 cm</p> <p>Table 140 = 67 cm Table 160 = 87 cm Table 180 = 99 cm Table 200 = 119 cm</p> <p>table height 76,5 cm</p>															
Description															
Dining room table															
Measures W/L		90/140 cm		90/160 cm		90/180 cm		90/200 cm		100/160 cm		100/180 cm		100/200 cm	
<p>guide rail beach solid Elongation colorglas or wood solid</p> <p>Extra charge Elongation</p> <p>+50/80/90/100 cm</p>															
Description															
extra charge elongation 50 cm (available for all tables)			extra charge elongation 80 cm (only available for table 160cm)				extra charge elongation 90 cm (only available for table 180cm)			extra charge elongation 100 cm (only available for table 200cm)					
Elongation		optiwhite	juraschlamm	Woodsolid	optiwhite	juraschlamm	Wood solid	optiwhite	juraschlamm	Wood solid	optiwhite	juraschlamm	Wood solid		
<p>Seat and backrest upholstered Back upholsterd (other fabric available)</p> <p>Seat height approx. 48 cm</p> <p>Synthetic glides on all chairs (felt glides included)</p> <p>Mention details: Fabric back Fabric seat</p> <p>W/D/H ca. 50/ 61/ 88 cm</p>															
Description															
Upholstered chair				Upholstered chair				Chair							
Fabric		Loden	Leather	Leather-Loden combined	Loden		Leather		Loden		Leather				
<p>Seat and backrest in leather acc. collection, Metal-parts in brushed Nickel (Stainless-Design) <b>NOT AVAILABLE IN LODEN!</b></p> <p><b>Back covering leather</b></p> <p>W/D/H ca. 46/ 54/ 90 cm      W/D/H ca. 53/ 54/ 90 cm</p> <p><b>Back seat sehlh, wood</b></p> <p>W/D/H ca. 46/ 54/ 90 cm      W/D/H ca. 53/ 54/ 90 cm</p> <p>Seat and backrest upholstered with loden or leather accord. to coll. suitably edged with leather piping (black leather piping with loden)</p> <p>W/D/H ca. 49/ 54/ 89 cm      W/D/H ca. 59/ 54/ 89 cm</p>															
Description															
Cantilevered chair		cantilevered chair, with armrests		cantilevered chair		cantilevered chair, with armrests		Upholstered chair		Upholstered chair, with armrests					
Fabric		Leather	Leather	Leather		Leather		Loden	Leather	Loden	Leather				

Seat height 49cm	<p><u>Upholstery seat:</u> Foamed material 70 mm Density 50 Hardness 75</p> <p>Fissure in beige</p> 				<p><u>Upholstery seat:</u> Foamed material 70 mm Density 50 Hardness 75</p> 									
Description	Upholstered seating bench				Upholstered seating bench with stollen									
W/D/H	140/81/84 cm	160/81/84 cm	180/81/84 cm	200/81/84 cm	180/58,7/88 cm	200/58,7/88 cm	220/58,7/88 cm	240/58,7/88 cm						
Sutring table size	140 cm	160 cm	180 cm	200 cm	140 cm	160 cm	180 cm	200 cm						
Fabric	Loden	Leather	Loden	Leather	Loden	Leather	Loden	Leather	Loden	Leather	Loden	Leather	Loden	Leather

	<p>removable front panel (Magnetic catchers)</p> <p>Cable duct with accent - solid, hacked oak (Coloure and structure different!)</p>  <p>W/D/H 15,6/ 5,8/ 20 cm</p>	<p>Conducts signals of customary remote control through closed furniture front.</p> <p>The TV equipment shouldn't be separated by carcass sides - they have to be well-positioned in one corpus.</p>	<ul style="list-style-type: none"> <li>- Motion sensor</li> <li>- 6x LED, 0,5 Watt</li> <li>- with charging cable</li> <li>- in case of USB rechargeable</li> <li>- individ. fixing under shelf</li> <li>- no cabling essential</li> </ul>  <p>W/D/H ca. 10/ 8,5/ 1 cm</p>	<p>Mains plug with USB-connect for loading of the Battery-LED-light (Standard USB-Recharger 5V/DC, 1 Ampere, 100-240 V)</p>  <p>W/D/H ca. 4/ 6,5/ 1,7 cm</p>
Description	Cable duct	Infrarot-Repeater	Battery-LED-light	USB-Recharger

	<p>CLV board veneered, edged around</p> <p>max. Length 252 cm max. Width 110 cm</p> <p>Thickness of material: 14,20 oder 23 mm</p>  <p>price per m2 (calculated min. 0,5 m2)</p>	<p><b>WOOD MAINTENANCE</b></p>		
		<p>250 ml Voglauer Maintenance oil and polishing cloth</p>  <p>The original Voglauer wood maintenance oil cleans and refreshes the surfaces and at the same time creates a breathable protective film.</p>	<p>Repair set comprises:</p> <p>100 ml Voglauer cleanser 100 ml Surface oil Scotch-Bride and polishing cloths</p>  <p>In order to fix little surface damages and impureness.</p>	
Description	Cover plate double sided veneered	Maintenance set for oiled surfaces	Repair set for oiled surfaces	

	<p><b>LEATHER MAINTENANCE</b></p>			
	<p>200 ml soft cleaner 200 ml maintenance cream with light protection Sponge and cloths</p>  <p>The original Voglauer leather maintenance set for thorough and yet gentle cleaning as well as impregnation of leather. <b>Recommended:</b> 2 - 4 applications per year.</p>	<p>Contents 200 ml</p>  <p>To remove strong, not fatty pollution and dust deposit on the leather.</p>	<p>Contents 200 ml</p>  <p>Highly effective impregnation and light protection. The dubbin gets refreshed and the leather stays soft and sleek, retarding the fading of the color.</p>	<p>Contents 200 ml</p>  <p>To refresh faded and galled leather.</p> <p><b>Recommended:</b> Impregnation with maintenance cream afterwards</p> <p style="text-align: center;"><b>Indicate colour of Leather!</b></p>
Description	Leather maintenance set	Leather intensive cleaner	Leather maintenance cream	Leather color lotion

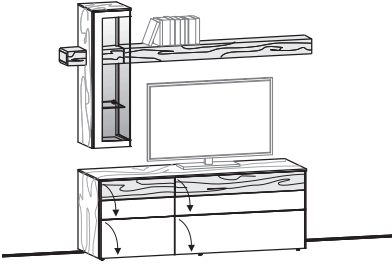
<p><b>SUGGESTION 113</b> W/D/H 209 / 55,8 / 203 cm</p>  <p>(Suggestions always without extra charge articles)</p>	Glass/ front side	optiwhite	juraschl.
	Extr. charge LS-lighting - switch		
	Extr. charge LF-lighting - remote & Dimmer		
	Extr. charge glass panel for lowboard (optiw. / juraschl.)		
	Extr. charge 2 Drawers instead of hatches for lowboard	<b>Quote: TOP or BOTTOM!</b>	
	Extr. charge Cable-management for lowboard		
	Suggestion (ill.) comprises:		
	1x Lowboard 176/67 mit Accent, 4 Hatches, make left 1x Suspended glass cabinets 32/113, 1 door, door stop left 1x beam-board 16 cm 1x beam-board 160 cm		

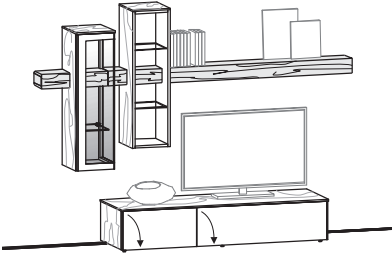
<p><b>SUGGESTION 125</b> W/D/H 265 / 55,8 / 195 cm</p>  <p>(Suggestions always without extra charge articles)</p>	Glass/ front side	optiwhite	juraschl.
	Extr. charge LS-lighting - switch		
	Extr. charge LF-Beleuchtung - remote + dimmer		
	Extr. charge glass panel for lowboard (optiw. / juraschl.)		
	Extr. charge Drawer 64 instead of hatch for lowboard		
	Extr. charge Drawer 112 instead of hatch for lowboard		
	Extr. charge Cable-management for lowboard		
	Suggestion (ill.) comprises:		
1x Lowboard 176/35, 2 Glass-hatches, make left 1x Suspended glass cabinets 32/113, 1 door, door stop left 1x Suspended rack 32/113, offen 1x beam-board 24 cm 1x beam-board 16 cm 1x beam-board 160 cm			

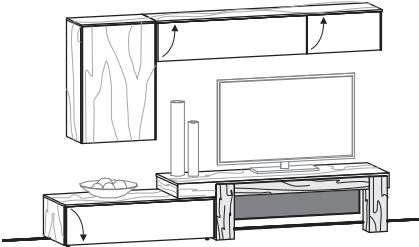
<p><b>SUGGESTION 137</b> W/D/H 276 / 57,8 / 179 cm</p>  <p>(Suggestions always without extra charge articles)</p>	Glass/ front side	optiwhite	juraschl.
	Extr. charge LS-lighting - switch		
	Extr. charge LF-lighting - remote & dimmer		
	Extr. charge glass panel for lowboard (optiw. / juraschl.)		
	Extr. charge Drawer instead of hatch for lowboard		
	Extr. charge built in Infrarotpeater for mediaelement		
	Extr. charge lateral Drawer for mediaelement		
	Suggestion (ill.) comprises:		
1x Lowboard 128/35, 1 Glass-hatch 1x Mediaelement 180 cm, make left 1x Suspended element 64/97, 1 wooden door, door stop left 1x Suspended element 192, 2 Glass-hatches nach oben, make right			

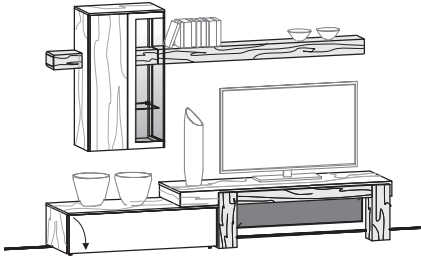
<p><b>SUGGESTION 149</b> W/D/H 276 / 57,8 / 195 cm</p>  <p>(Suggestions always without extra charge articles)</p>	Glass/ front side	optiwhite	juraschl.
	Extr. charge LS-lighting - switch		
	Extr. charge LF-lighting - remote & Dimmer		
	Extr. charge glass panel for lowboard (optiw. / juraschl.)		
	Extr. charge Drawer instead of hatch for lowboard		
	Extr. charge built in Infrarotrepeater for mediaelement		
	Extr. charge lateral Drawer for mediaelement		
	<p>Suggestion (ill.) comprises:</p> <ul style="list-style-type: none"> <li>1x Lowboard 128/35, 1 Glass-hatch</li> <li>1x Mediaelement 180 cm, make left</li> <li>1x Suspended glass cabinets 64/113, 1 door, door stop left</li> <li>1x beam-board 24 cm</li> <li>1x beam-board 176 cm</li> </ul>		

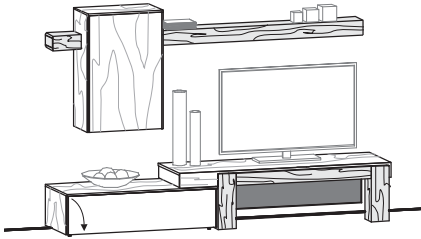
<p><b>SUGGESTION 161</b> W/D/H 276 / 57,8 / 179 cm</p>  <p>(Suggestions always without extra charge articles)</p>	Glass/ front side	optiwhite	juraschl.
	Extr. charge LS-lighting - switch		
	Extr. charge LF-lighting - remote & Dimmer		
	Extr. charge glass panel for lowboard (optiw. / juraschl.)		
	Extr. charge drawer instead of hatch for lowboard		
	Extr. charge built in Infrarotrepeater for mediaelement		
	Extr. charge lateral Drawer for mediaelement		
	<p>Suggestion (ill.) comprises:</p> <ul style="list-style-type: none"> <li>1x Lowboard 128/35, 1 Glass-hatch</li> <li>1x Mediaelement 180 cm, make left</li> <li>1x Suspended element 64/97, 1 wooden door, door stop left</li> <li>1x beam-board 24 cm</li> <li>1x beam-board 176 cm</li> </ul>		

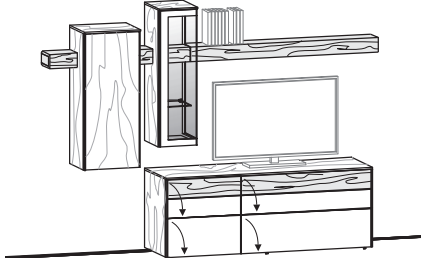
<p><b>SUGGESTION 173</b> W/D/H 281 / 55,8 / 203 cm</p>  <p>(Suggestions always without extra charge articles)</p>	Glass/ front side	optiwhite	juraschl.
	Extr. charge LS-lighting - switch		
	Extr. charge LF-lighting - remote & Dimmer		
	Extr. charge glass panel for lowboard (optiw. / juraschl.)		
	Extr. charge 2 drawers instead of Hatches for lowboard	<b>Quote: TOP or BOTTOM!</b>	
	Extr. charge Cable-management for lowboard		
	<p>Suggestion (ill.) comprises:</p> <ul style="list-style-type: none"> <li>1x Lowboard 176/67 mit Accent, 4 Hatches, make left</li> <li>1x Suspended element 48/113, 1 wooden door, door stop left</li> <li>1x Suspended glass cabinets 32/113, 1 door, door stop left</li> <li>1x beam-board 24 cm</li> <li>1x beam-board 16 cm</li> <li>1x beam-board 160 cm</li> </ul>		

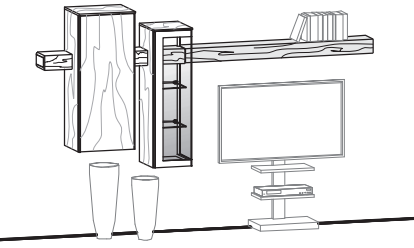
<p><b>SUGGESTION 185</b> W/D/H 281 / 37,8 / 187 cm</p>  <p>(Suggestions always without extra charge articles)</p>	Glass/ front side	optiwhite	juraschl.
	Extr. charge LS-lighting - switch (D-2L032, D-2L02, D-2L01, D-2LS16)		
	Extr. charge LF-lighting - remote & Dimmer (D-2L032, D-2L02, D-2L01, D-2LF16)		
	<p>Suggestion (ill.) comprises:</p> <ul style="list-style-type: none"> <li>1x Suspended element 48/113, 1 wooden door, door stop left</li> <li>1x Suspended glass cabinets 32/113, 1 door, door stop left</li> <li>1x beam-board 24 cm</li> <li>1x beam-board 16 cm</li> <li>1x beam-board 160 cm</li> </ul>		

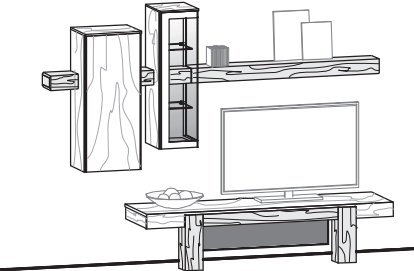
<p><b>SUGGESTION 197</b> W/D/H 281 / 57,8 / 211 cm</p>  <p>(Suggestions always without extra charge articles)</p>	Glass/ front side	optiwhite	juraschl.
	Extr. charge LS-lighting - switch (D-2L032, D-2L02, D-2L01, D-2LS16)		
	Extr. charge LF-lighting - remote & Dimmer (D-2L032, D-2L02, D-2L01, D-2LF16)		
	<p>Extr. charge built in Infrarotpeater for mediaelement (D-I)</p> <p>Extr. charge lateral Drawer for mediaelement (D-SM) <b>Mention: Fitting LEFT or RIGHT!</b></p> <p>Suggestion (ill.) comprises:</p> <ul style="list-style-type: none"> <li>1x Mediaelement 210 cm</li> <li>1x Suspended element 48/113, 1 wooden door, door stop left</li> <li>1x Suspended glass cabinets 32/113, 1 door, door stop left</li> <li>1x beam-board 24 cm</li> <li>1x beam-board 16 cm</li> <li>1x beam-board 160 cm</li> </ul>		

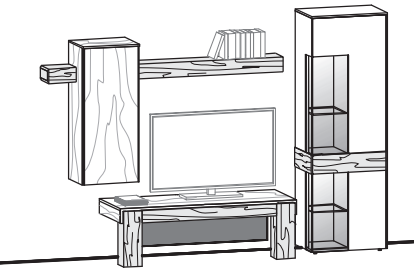
<p><b>SUGGESTION 209</b> W/D/H 282 / 57,8 / 195,4 cm</p>  <p>(Suggestions always without extra charge articles)</p>	Glass/ front side	optiwhite	juraschl.
	Extr. charge LS-lighting - switch (D-LS4, D-2L02, D-2LS12)		
	Extr. charge LF-lighting - remote & Dimmer (D-LF4, D-2L02, D-2LF12)		
	<p>Extr. charge built in Infrarotpeater for mediaelement (D-I)</p> <p>Suggestion (ill.) comprises:</p> <ul style="list-style-type: none"> <li>1x Mediaelement 150 cm</li> <li>1x Cabinet 64, 1 door, door stop right</li> <li>1x Suspended element 48/113, 1 wooden door, door stop left</li> <li>1x beam-board 24 cm</li> <li>1x beam-board 128 cm</li> </ul>		

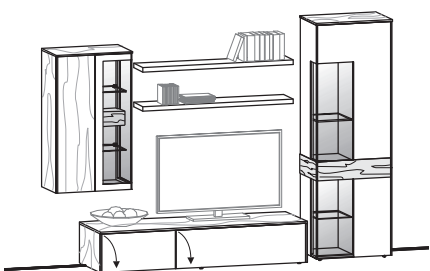

<p><b>SUGGESTION 221</b> W/D/H 285 / 55,8 / 195,4 cm</p>  <p>(Suggestions always without extra charge articles)</p>	Glass/ front side	optiwhite	juraschl.
	Extr. charge LS-lighting - switch		
	Extr. charge LF-lighting - remote & Dimmer		
	Extr. charge glass panel for lowboard (optiw. / juraschl.)		
	Extr. charge Drawer 64 instead of hatch for lowboard		
	Extr. charge Drawer 112 instead of hatch for lowboard		
	Extr. charge Cable-management for lowboard		
	<p>Suggestion (ill.) comprises:</p> <ul style="list-style-type: none"> <li>1x Lowboard 176/35, 2 Glass-hatches, make left</li> <li>1x Cabinet 64, 1 door, door stop right</li> <li>1x Suspended glass cabinets 64/113, 1 door, door stop left</li> <li>2x Wandsteckbord 128 cm</li> </ul>		

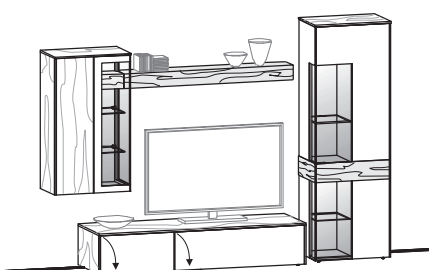
<p><b>SUGGESTION 233</b> W/D/H 285 / 55,8 / 195,4 cm</p>  <p>(Suggestions always without extra charge articles)</p>	Glass/ front side	optiwhite	juraschl.
	Extr. charge LS-lighting - switch		
	Extr. charge LF-lighting - remote & Dimmer		
	Extr. charge glass panel for lowboard (optiw. / juraschl.)		
	Extr. charge drawer 64 instead of hatch for lowboard		
	Extr. charge drawer 112 instead of hatch for lowboard		
	Extr. charge Cable-management for lowboard		
	<p>Suggestion (ill.) comprises:</p> <ul style="list-style-type: none"> <li>1x Lowboard 176/35, 2 Glass-hatches, make left</li> <li>1x Cabinet 64, 1 door, door stop right</li> <li>1x Suspended glass cabinets 64/113, 1 door, door stop left</li> <li>1x beam-board 144 cm</li> </ul>		

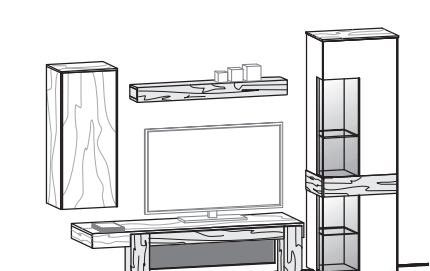
<p><b>SUGGESTION 245</b> W/D/H 286 / 57,8 / 195,4 cm</p>  <p>(Suggestions always without extra charge articles)</p>	Glass/ front side	optiwhite	juraschl.
	Extr. charge LS-lighting - switch		
	Extr. charge LF-lighting - remote & Dimmer		
	Extr. charge built in Infrarotrepeater for mediaelement		
	Extr. charge lateral drawer for mediaelement		
	<p>Suggestion (ill.) comprises:</p> <ul style="list-style-type: none"> <li>1x Mediaelement 180 cm, make left</li> <li>1x Cabinet 64, 1 door, door stop right</li> <li>1x Suspended element 48/113, 1 wooden door, door stop left</li> <li>1x beam-board 128 cm</li> </ul>		

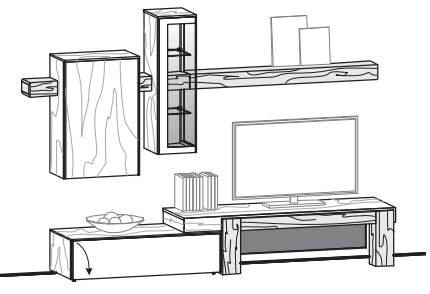
<p><b>SUGGESTION 257</b> W/D/H 300 / 57,8 / 211 cm</p>  <p>(Suggestions always without extra charge articles)</p>	Glass/ front side	optiwhite	juraschl.
	Extr. charge LS-lighting - switch		
	Extr. charge LF-lighting - remote & Dimmer		
	Extr. charge glass panel for lowboard (optiw. / juraschl.)		
	Extr. charge drawer instead of hatch for lowboard		
	Extr. charge built in Infrarotrepeater for mediaelement		
	Extr. charge lateral Drawer for mediaelement		
	Suggestion (ill.) comprises:		
	<ul style="list-style-type: none"> <li>1x Lowboard 128/35, 1 Glass-hatch</li> <li>1x Mediaelement 180 cm, make left</li> <li>1x Suspended element 64/97, 1 wooden door, door stop left</li> <li>1x Suspended glass cabinets 32/113, 1 door, door stop left</li> <li>1x beam-board 24 cm</li> <li>1x beam-board 16 cm</li> <li>1x beam-board 160 cm</li> </ul>		

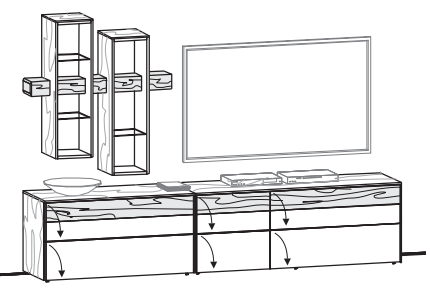
<p><b>SUGGESTION 269</b> W/D/H 304,4 / 55,8 / 211 cm</p>  <p>(Suggestions always without extra charge articles)</p>	Glass/ front side	optiwhite	juraschl.
	Extr. charge LS-lighting - switch		
	Extr. charge LF-lighting - remote & Dimmer		
	Extr. charge glass panel für Lowboarde (optiw. / juraschl.)		
	Extr. charge drawer instead of Hatch f. Lowboard 128	<b>Quote: TOP or BOTTOM!</b>	
	Extr. charge 2 drawers instead of Hatches f. Lowboard 176	<b>Quote: TOP or BOTTOM!</b>	
	Extr. charge Cable-management for lowboard 176		
	Suggestion (ill.) comprises:		
	<ul style="list-style-type: none"> <li>1x Lowboard 128/67 mit Accent, 2 Hatches</li> <li>1x Lowboard 176/67 mit Accent, 4 Hatches, make left</li> <li>1x Suspended rack 32/113, offen</li> <li>1x Suspended rack 32/113, offen</li> <li>2x beam-board 16 cm</li> <li>1x beam-board 24 cm</li> </ul>		

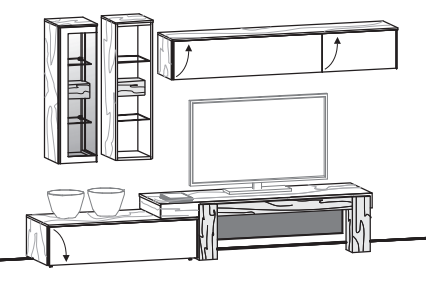
<p><b>SUGGESTION 281</b> W/D/H 304 / 57,8 / 195 cm</p>  <p>(Suggestions always without extra charge articles)</p>	Glass/ front side	optiwhite	juraschl.
	Extr. charge LS-lighting - switch		
	Extr. charge LF-lighting - remote & Dimmer		
	Extr. charge glass panel for lowboard (optiw. / juraschl.)		
	Extr. charge drawer instead of hatch for lowboard		
	Extr. charge built in Infrarotrepeater for mediaelement		
	Extr. charge lateral Drawer for mediaelement		
	Suggestion (ill.) comprises:		
	<ul style="list-style-type: none"> <li>1x Lowboard 128/35, 1 Glass-hatch</li> <li>1x Mediaelement 180 cm, make left</li> <li>1x Suspended glass cabinets 32/113, 1 door, door stop left</li> <li>1x Suspended rack 32/113, offen</li> <li>1x Suspended element 192, 2 Glass-hatch nach oben, make right</li> </ul>		

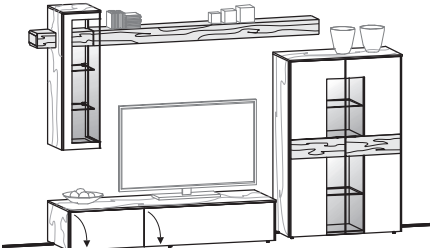
<p><b>SUGGESTION 293</b> W/D/H 304 / 55,8 / 195 cm</p>  <p>(Suggestions always without extra charge articles)</p>	Glass/ front side	optiwhite	juraschl.
	Extr. charge LS-lighting - switch		
	Extr. charge LF-lighting - remote & Dimmer		
	Extr. charge glass panel for lowboard (optiw. / juraschl.)		
	Extr. charge drawer 64 instead of hatch for lowboard		
	Extr. charge drawer 112 instead of hatch for lowboard		
	Extr. charge Cable-management for lowboard		
	<p>Suggestion (ill.) comprises:</p> <ul style="list-style-type: none"> <li>1x Lowboard 176/35, 2 Glass-hatches, make left</li> <li>1x Highboard 96, 2 doors</li> <li>1x Suspended glass cabinets 32/113, 1 door, door stop left</li> <li>1x beam-board 16 cm</li> <li>1x beam-board 192 cm</li> </ul>		

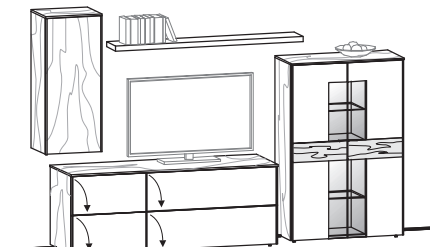
<p><b>SUGGESTION 305</b> W/D/H 304 / 55,8 / 195 cm</p>  <p>(Suggestions always without extra charge articles)</p>	Glass/ front side	optiwhite	juraschl.
	Extr. charge LS-lighting - switch		
	Extr. charge LF-lighting - remote & Dimmer		
	Extr. charge glass panel for lowboard (optiw. / juraschl. )		
	Extr. charge 2 drawers instead of Hatches for lowboard	<b>Quote: TOP or BOTTOM!</b>	
	Extr. charge Cable-management for lowboard		
	<p>Suggestion (ill.) comprises:</p> <ul style="list-style-type: none"> <li>1x Lowboard 176/67, 4 Glass-hatches, make left</li> <li>1x Highboard 96, 2 doors</li> <li>1x Suspended element 48/113, 1 wooden door, door stop left</li> <li>1x Wandsteckbord 160 cm</li> </ul>		

<p><b>SUGGESTION 317</b> W/D/H 313 / 55,8 / 195 cm</p>  <p>(Suggestions always without extra charge articles)</p>	Glass/ front side	optiwhite	juraschl.
	Extr. charge LS-lighting - switch		
	Extr. charge LF-lighting - remote & Dimmer		
	Extr. charge glass panel für Lowboarde (optiw./juraschl.)		
	Extr. charge drawer instead of Hatch f. Lowboard 128		
	Extr. charge drawer 112 instead of hatch for lowboard 176		
	Extr. charge drawer 64 instead of hatch for lowboard 176		
	Extr. charge Cable-management for lowboard 176		
<p>Suggestion (ill.) comprises:</p> <ul style="list-style-type: none"> <li>1x Lowboard 128/35, 1 Glass-hatch</li> <li>1x Lowboard 176/35, 2 Glass-hatches, make right</li> <li>1x Suspended element 64/97, 1 wooden door, door stop left</li> <li>1x Suspended glass cabinets 32/113, 1 door, door stop left</li> <li>1x beam-board 24 cm</li> <li>1x beam-board 16 cm</li> <li>1x beam-board 176 cm</li> </ul>			

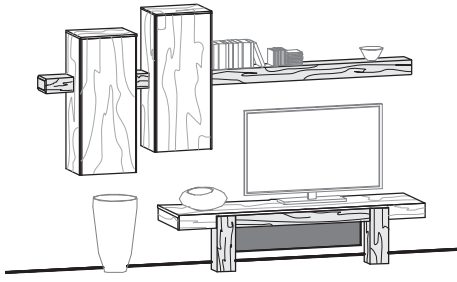
<p><b>SUGGESTION 329</b> W/D/H 312 / 57,8 / 211 cm</p>  <p>(Suggestions always without extra charge articles)</p>		
	Extr. charge LS-lighting - switch	
	Extr. charge LF-lighting - remote & Dimmer	
	Extr. charge built in Infrarotpeater for mediaelement	
	Extr. charge lateral Drawer for mediaelement	<b>Mention: Fitting LEFT or RIGHT!</b>
	<p>Suggestion (ill.) comprises:</p> <ul style="list-style-type: none"> <li>1x Mediaelement 210 cm</li> <li>2x Suspended element 48/113, 1 wooden door, door stop left</li> <li>1x beam-board 24 cm</li> <li>1x beam-board 16 cm</li> <li>1x beam-board 176 cm</li> </ul>	

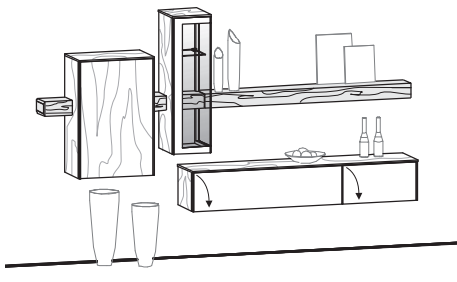
<p><b>SUGGESTION 341</b> W/D/H 313 / 38,1 / 203 cm</p>  <p>(Suggestions always without extra charge articles)</p>	Glass/ front side	optiwhite	juraschl.
	Extr. charge LS-lighting - switch		
	Extr. charge LF-Beleuchtung - Funk+Dimmer		
	<p>Suggestion (ill.) comprises:</p> <ul style="list-style-type: none"> <li>1x Suspended element 192, 2 Glass-hatch nach unten, make right</li> <li>1x Suspended element 64/97, 1 wooden door, door stop left</li> <li>1x Suspended glass cabinets 32/113, 1 door, door stop left</li> <li>1x beam-board 24 cm</li> <li>1x beam-board 16 cm</li> <li>1x beam-board 176 cm</li> </ul>		

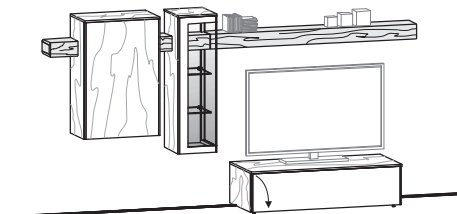
<p><b>SUGGESTION 353</b> W/D/H 313 / 55,8 / 163 cm</p>  <p>(Suggestions always without extra charge articles)</p>	Glass/ front side	optiwhite	juraschl.
	Extr. charge LS-lighting - switch		
	Extr. charge LF-lighting - remote & Dimmer		
	Extr. charge glass panel for lowboard (optiw./ juraschl.)		
	Extr. charge drawer instead of Hatch f. Lowboard		
Extr. charge Cable-management for lowboard			
<p>Suggestion (ill.) comprises:</p> <ul style="list-style-type: none"> <li>1x Lowboard 128/35, 1 Glass-hatch</li> <li>1x Suspended element 64/97, 1 wooden door, door stop left</li> <li>1x Suspended glass cabinets 32/113, 1 door, door stop left</li> <li>1x beam-board 24 cm</li> <li>1x beam-board 16 cm</li> <li>1x beam-board 176 cm</li> </ul>			

<p><b>SUGGESTION 365</b> W/D/H 313 / 37,8 / 171 cm</p>  <p>(Suggestions always without extra charge articles)</p>	Glass/ front side	optiwhite	juraschl.
	Extr. charge LS-lighting - switch		
	Extr. charge LF-lighting - remote & Dimmer		
	<p>Suggestion (ill.) comprises:</p> <ul style="list-style-type: none"> <li>1x Suspended element 64/97, 1 wooden door, door stop left</li> <li>1x Suspended glass cabinets 32/113, 1 door, door stop left</li> <li>1x beam-board 24 cm</li> <li>1x beam-board 16 cm</li> <li>1x beam-board 176 cm</li> </ul>		

<p><b>SUGGESTION 377</b> W/D/H 313 / 57,8 / 211 cm</p>  <p>(Suggestions always without extra charge articles)</p>	Glass/ front side	optiwhite	juraschl.
	Extr. charge LS-lighting - switch		
	Extr. charge LF-lighting - remote & Dimmer		
	Extr. charge built in Infrarotpeater for mediaelement		
	Extr. charge lateral drawer for mediaelement	<b>Mention: Fitting LEFT or RIGHT!</b>	
<p>Suggestion (ill.) comprises:</p> <ul style="list-style-type: none"> <li>1x Mediaelement 210 cm</li> <li>1x Suspended element 64/97, 1 wooden door, door stop left</li> <li>1x Suspended glass cabinets 32/113, 1 door, door stop left</li> <li>1x beam-board 24 cm</li> <li>1x beam-board 16 cm</li> <li>1x beam-board 176 cm</li> </ul>			

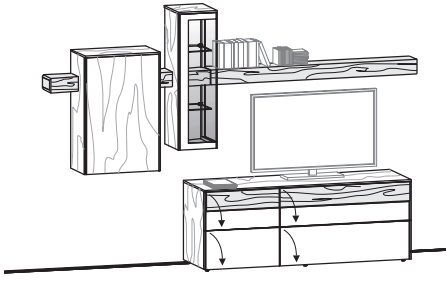
<p><b>SUGGESTION 389</b> W/D/H 313 / 55,8 / 211 cm</p>  <p>(Suggestions always without extra charge articles)</p>	Glass/ front side	optiwhite	juraschl.
	Extr. charge LS-lighting - switch		
	Extr. charge LF-lighting - remote & Dimmer		
	Extr. charge glass panel for lowboard (optiw. / juraschl.)		
	Extr. charge 2 drawers instead of Hatches for lowboard	<b>Quote: TOP or BOTTOM!</b>	
Extr. charge Cable-management for lowboard			
<p>Suggestion (ill.) comprises:</p> <ul style="list-style-type: none"> <li>1x Lowboard 176/67 mit Accent, 4 Hatches, make left</li> <li>1x Suspended element 64/97, 1 wooden door, door stop left</li> <li>1x Suspended glass cabinets 32/113, 1 door, door stop left</li> <li>1x beam-board 24 cm</li> <li>1x beam-board 16 cm</li> <li>1x beam-board 176 cm</li> </ul>			

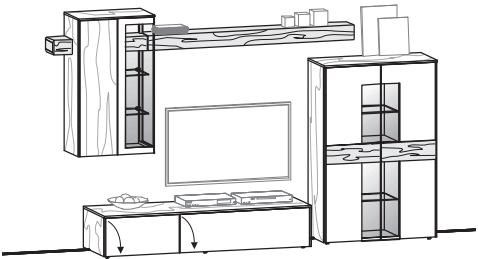
<p><b>SUGGESTION 401</b> W/D/H 320 / 55,8 / 195 cm</p>  <p>(Suggestions always without extra charge articles)</p>	Glass/ front side	optiwhite	juraschl.
<p>Suggestion (ill.) comprises: 1x Lowboard 176/35, 2 Glass-hatches, make left                  1x Highboard 96, 2 doors                  1x Suspended glass cabinets 64/113, 1 door, door stop left                  1x beam-board 16 cm                  1x beam-board 176 cm</p>			

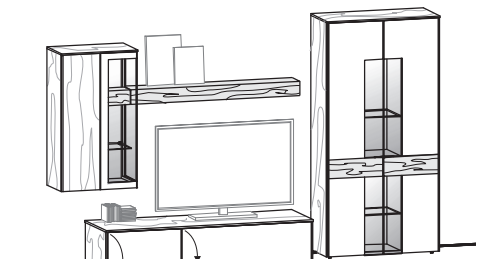
<p><b>SUGGESTION 413</b> W/D/H 321 / 55,8 / 195,4 cm</p>  <p>(Suggestions always without extra charge articles)</p>	Glass/ front side	optiwhite	juraschl.
<p>Suggestion (ill.) comprises: 1x Lowboard 176/35, 2 Glass-hatches, make left                  1x Cabinet 96, 2 doors                  1x Suspended glass cabinets 64/113, 1 door, door stop left                  1x beam-board 144 cm</p>			

<p><b>SUGGESTION 425</b> W/D/H 328 / 57,8 / 195 cm</p>  <p>(Suggestions always without extra charge articles)</p>	Glass/ front side	optiwhite	juraschl.
<p>Suggestion (ill.) comprises: 1x Lowboard 128/35, 1 Glass-hatch                  1x Mediaelement 210 cm                  2x Suspended element 48/113, 1 wooden door, door stop left                  1x Suspended element 192, 2 Glass-hatch nach oben, make right                  1x beam-board 24 cm                  1x beam-board 16 cm</p>			

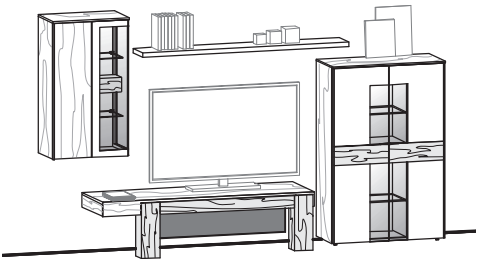

<p><b>SUGGESTION 437</b> W/D/H 333 / 57,8 / 195 cm</p>  <p>(Suggestions always without extra charge articles)</p>	Glass/ front side	optiwhite	juraschl.
	Extr. charge LS-lighting - switch		
	Extr. charge LF-lighting - remote & Dimmer		
	Extr. charge built in Infrarotrepeater for mediaelement		
	Extr. charge lateral drawer for mediaelement		
	<p>Suggestion (ill.) comprises:</p> <ul style="list-style-type: none"> <li>1x Mediaelement 180 cm, make left</li> <li>1x Highboard 96, 2 doors</li> <li>1x Suspended glass cabinets 64/113, 1 door, door stop left</li> <li>1x Wandsteckbord 176 cm</li> </ul>		

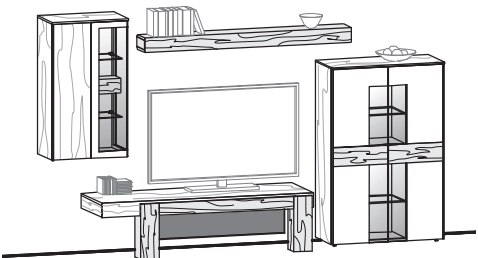
<p><b>SUGGESTION 449</b> W/D/H 333 / 57,8 / 195 cm</p>  <p>(Suggestions always without extra charge articles)</p>	Glass/ front side	optiwhite	juraschl.
	Extr. charge LS-lighting - switch		
	Extr. charge LF-lighting - remote & Dimmer		
	Extr. charge built in Infrarotrepeater for mediaelement		
	Extr. charge lateral drawer for mediaelement		
	<p>Suggestion (ill.) comprises:</p> <ul style="list-style-type: none"> <li>1x Mediaelement 180 cm, make left</li> <li>1x Highboard 96, 2 doors</li> <li>1x Suspended glass cabinets 64/113, 1 door, door stop left</li> <li>1x beam-board 176 cm</li> </ul>		

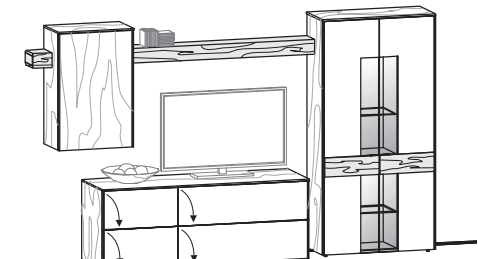
<p><b>SUGGESTION 461</b> W/D/H 336 / 55,8 / 195,4 cm</p>  <p>(Suggestions always without extra charge articles)</p>	Glass/ front side	optiwhite	juraschl.
	Extr. charge LS-lighting - switch		
	Extr. charge LF-lighting - remote & Dimmer		
	Extr. charge glass panel for lowboard (optiw./ juraschl.)		
	Extr. charge 2 drawers instead of Hatches for lowboard	<b>Quote: TOP or BOTTOM!</b>	
	Extr. charge Cable-management for lowboard		
	<p>Suggestion (ill.) comprises:</p> <ul style="list-style-type: none"> <li>1x Lowboard 176/67, 4 Glass-hatches, make left</li> <li>1x Cabinet 96, 2 doors</li> <li>1x Suspended element 64/97, 1 wooden door, door stop left</li> <li>1x beam-board 16 cm</li> <li>1x beam-board 160 cm</li> </ul>		

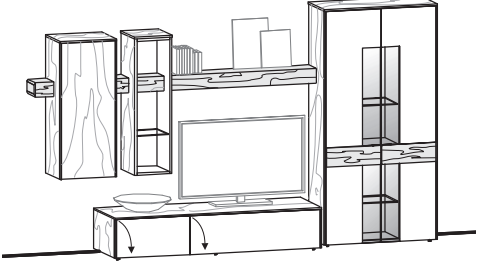
<p><b>SUGGESTION 473</b> W/D/H 336 / 55,8 / 195,4 cm</p>  <p>(Suggestions always without extra charge articles)</p>	Glass/ front side	optiwhite	juraschl.
<p>Suggestion (ill.) comprises:</p> <ul style="list-style-type: none"> <li>1x Lowboard 176/35, 2 Glass-hatches, make left</li> <li>1x Cabinet 96, 2 doors</li> <li>1x Suspended element 48/113, 1 wooden door, door stop left</li> <li>1x Suspended rack 32/113, offen</li> <li>2x beam-board 16 cm</li> <li>1x beam-board 128 cm</li> </ul>			

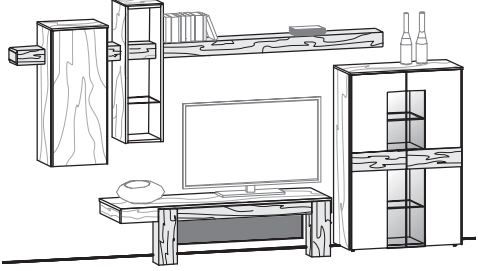
<p><b>SUGGESTION 485</b> W/D/H 373 / 57,8 / 211 cm</p>  <p>(Suggestions always without extra charge articles)</p>	Glass/ front side	optiwhite	juraschl.
<p>Suggestion (ill.) comprises:</p> <ul style="list-style-type: none"> <li>1x Mediaelement 180 cm, make left</li> <li>1x Highboard 96, 2 doors</li> <li>1x Suspended element 48/113, 1 wooden door, door stop left</li> <li>1x Suspended rack 32/113, offen</li> <li>1x beam-board 24 cm</li> <li>1x beam-board 16 cm</li> <li>1x beam-board 192 cm</li> </ul>			

**1. General**

1.1. The following terms and conditions of sale and shipment are valid for all business relationships (such as purchasing agreements, contracts of work and labour, fitting agreements, etc.) between VOGLAUER MOBELWERK Gschwandtner & Zwilling GmbH & Co KG, hereinafter referred to as VOGLAUER, and its customers. Customers accept these terms as binding upon them by placing an order or closing a contract with VOGLAUER. Deviating, conflicting or amending General Terms, whether known to VOGLAUER or not, cannot become part of any contract with VOGLAUER except by express written acceptance. Inasmuch as conditions deviating from these terms and conditions of sale and shipment are agreed to in writing as part of a contract, the stipulations of the contract have priority.

1.2. VOGLAUER closes contracts strictly only with registered companies. Should in exceptional cases a customer be a customer in the sense of consumer protection laws, such customers have the obligation to notify VOGLAUER of the fact. Otherwise, such customers will be held liable. These terms and conditions of sale and shipment will be valid for business with consumers only as far as they are in compliance with imperative stipulations of consumer protection laws.

**2. Proposal, Prices**

2.1. All prices quoted by VOGLAUER in proposals and price lists are non-binding and net prices except if and where it is clearly indicated that VAT is included. Prices quoted by VOGLAUER are free buyer's address, fitting excluded. VAT will be calculated separately on the basis of the legal provisions valid on the day of delivery and performance of services. VOGLAUER reserves the right to perform technical and other changes without reason. Purchase orders without prices will be processed using the applicable list prices valid the day of arrival of the order.

2.2. If goods or services are delivered later than the agreed date for reasons other than late delivery culpably caused by VOGLAUER, VOGLAUER has the right to raise the prices accordingly. Such price correction will take into account changes of labour costs according to collective treaties and actual costs for performance such as costs of material, energy, transport, financing of external services, etc. between agreed and actual delivery dates.

2.3. Export deliveries will always be charged and payable in Euros. In cases where payment is expressly agreed in a different currency, invoicing will be on the basis of the exchange rate valid on the date of order acknowledgement by VOGLAUER. For this calculation, only exchange rates calculated by Austrian banks will be relevant.

**3. Order Acceptance, Subject Matter of Orders**

3.1. Purchase orders issued to VOGLAUER will result in a contractual relationship only in written order acknowledgement or delivery of goods or of an invoice by VOGLAUER. Customers have the obligation to provide comprehensive and correct documentation required for the production of the goods (measurements, blueprints, etc.) with the purchase order. Additional costs possibly inflicted by deviation of the actual situation from the documents or blueprints provided by customers as well as additional costs resulting from late provision of such documents will be carried by the customer. Changes to accepted orders will only be possible by written consent.

3.2. If at the time of order placement the ordered goods are not fully specified in all detail (especially technically), a preliminary order acknowledgement will be issued. Customers have the obligation to deliver further detail (actual measurements, etc.) in such time as to allow delivery on time. Upon delivery of the details, a final order acknowledgement will be issued which determines the subject matter of the contract in a binding fashion unless customers send their dissent in writing immediately. If so, the delivery contract will remain valid as by the preliminary order acknowledgement. In case of changes to an order communicated after a preliminary order acknowledgement has been issued, the prices will be adapted to a possibly precursory estimate.

**4. Shipment, Delivery**

4.1. Unless agreed otherwise, delivery will be free to customer's address. Transport insurance will be closed only if expressly requested by the customer. Costs arising from this will be carried by the customer. Unless agreed otherwise in writing, peril of price will be transferred to the customer at the time of shipment of the goods, or in case of late acceptance by the customer, at the time of readiness for shipment by VOGLAUER.

4.2. Unless agreed otherwise in writing, the choice of the place of shipment and the way and means of transport is in VOGLAUER's best discretion, without acceptance of any liability for cheapest or fastest transport. Delivery dates will in any event be non-binding unless expressly agreed to the contrary.

4.3. As a matter of principle, the agreed delivery periods are counted from the date of order acknowledgement. If VOGLAUER is at that time (start of lead time) not in possession of the documentation required for production such as especially actual room measurements, lead time starts at the date of receipt by VOGLAUER of the last document required. Customers have the obligation to provide such documentation in a timely manner. Delivery dates (lead times) will be extended by fitting delays not caused by VOGLAUER. In case a down payment is to be made by the customer, the lead-time will not be counted before the day of its receipt by VOGLAUER.

4.4. If acceptance of the delivered goods by the customer is delayed, whether culpably or otherwise, VOGLAUER has the right to ask a storage charge to an amount customary in that place. Furthermore, VOGLAUER has the right to withdraw from the delivery contract, upon which the customer has to pay the difference between the agreed price and the expectable revenue from realization of the deliverable goods. In case of included fitting, customers have the obligation to accept the contractual items immediately after completion in a visit. If acceptance is denied, the purchased goods are deemed accepted.

4.5. In case that VOGLAUER fails to meet delivery dates by more than 3 weeks, customers have the right to withdraw from the contract after a reasonable period of grace. If such delay is due to operational reasons VOGLAUER cannot prevent with due diligence of a scrupulous merchant (especially strike, disruption, raw material shortage, etc.), customers will be entitled to withdraw from the contract after a two-month delay after a reasonable period of grace.

**5. Withdrawal from Contract**

5.1. If a customer fails to fulfill contractual obligations in full or in part, VOGLAUER has the right to withdraw from the contract. The right to withdraw from the contract can be declared for only part(s) of the goods to be delivered. In such cases, VOGLAUER has the obligation to deliver the part of the shipment which is not affected by the withdrawal and the customer has the obligation to make payment for that part.

5.2. If VOGLAUER withdraws from a contract for reasons for which the customer is answerable without necessarily being culpable, or if customer withdraws from a contract without being entitled to do so, customer has the obligation to cover the costs of preparatory efforts by VOGLAUER (material purchased, special services, labour expenditure, etc.). VOGLAUER has the choice between the right to charge a lump sum of 25% of the total amount of the contract without provision of specific evidence for individual efforts. Custom designs already produced by VOGLAUER must be paid for

in full minus fitting and shipment costs.

**6. Fitting**

6.1. In cases where fitting is part of the agreement, customer has the obligation to provide for orderly vehicle access all the way to the rooms to be furnished. Where means of transportation such as cranes and lifts exist, these will be provided for use by VOGLAUER or its subcontractors free of charge.

6.2. Customer accepts liability for storage of the delivered goods on the construction site. This specifically includes theft-protected and dry storage on the construction site.

6.3. Customer will make all necessary provisions so that fitting can be performed without delay; specifically that assembly filters not be hampered by other craftspeople. Also, the fitting areas of the rooms to be furnished must be heated, clean and sufficiently lighted where required and electric power is to be provided. Costs for electricity and water will be carried by the customer. Carpeted floors must be made slippery-proof and sufficiently covered to prevent soiling and damage by the customer.

6.4. If fitting includes connection with objects owned by the customer or third parties (e.g. Fastening to walls by drilling or chiseling), customer will warn VOGLAUER of perilous locations prior to the commencement of such work, specifically the exact location of electric cables, gas and water pipes and other supply systems will be communicated.

6.5. VOGLAUER has no obligation to inspect the properties of walls or objects to which VOGLAUER parts will be connected. Customer, on the other hand, has the obligation to notify VOGLAUER of properties of walls or objects possibly impairing simple and problem-free fitting. Any additional work and expense resulting from unpredicted properties of walls and objects will be charged to the customer.

6.6. Additional costs for overtime authorized and fitting delays caused by the customer as well as work not included in the order acknowledgement or work caused by inadequate environment will be charged separately. This will also be the case if VOGLAUER has offered fitting for a lump sum or for free as a discount.

6.7. Customer will at their own costs take care of cleaning of the rooms after fitting. Lack of contractual stipulations to the contrary, fitting services offered by VOGLAUER do not include fitting and connecting of electric equipment of any kind of lighting appliances. Unless agreed otherwise, such work is to be performed by authorized craftsmen at customer's own expense. Packaging material will be disposed of by the customer at his or her own expense.

**7. Notification of Defects**

Upon delivery, customers must immediately inspect the goods for possible defects. Incomplete or wrong shipment as well as complaints for recognizable defects will be directed to VOGLAUER in writing immediately upon receipt of the goods, non-recognizable defects immediately upon their discovery. The notification must indicate clearly the kind and extent of the alleged defect. In case of late notification of defects and errors, the shipment will be considered approved, in which case warranty claims are fully ruled out.

**8. Warranty**

VOGLAUER provides warranty for the delivered goods for a period of one year from the shipment date. For electric implements and lighting appliances delivered by VOGLAUER, the warranty period will be six months.

In cases of justified and timely notification of defects, VOGLAUER will, reasonably taking into account customer's interests, provide warranty by improvement, purchase price. The choice of warranty method is VOGLAUER's. If VOGLAUER fails to meet warranty obligations within reasonable time, customer has the right to a reasonable price reduction or to withdraw from the contract. Activities started by VOGLAUER due to unjustified notifications of defect are considered purchase orders, and customers have the obligation to pay for the services rendered thereunder.

Excluded from the warranty are specifically:

- Goods provided by the customer;
- Damages resulting from deficiencies of the environment (e.g. faulty walls, construction material moisture, construction deficiencies, etc.);
- Compatibility of material used by VOGLAUER with other parts and properties of the rooms to furnish, such as other furnishing, lighting colors, heating, etc.;
- Deformation and crevices of solid wood used
- Function of the delivered goods and suitability of the material used if the design has been made by the customer or his agent (e.g. architect);
- Minor deviations of hues and surface or veneer structures of the delivered goods;

**9. Exclusion from Liability**

9.1. VOGLAUER can be held liable for damages outside of the applicability of the product liability law only in cases of intent or gross negligence. Liability for slight negligence is foreclosed, as is compensation for consequential damage and financial loss, failure to realize savings or profit, losses from interest and damages from third party claims against the customer.

9.2. Within the applicability of the product liability law, VOGLAUER will be liable for personal damage and for material damage suffered by consumers. VOGLAUER will not be liable for material damage suffered by companies. Regress by the customer as defined in § 933b ABGB (Austrian General Law) is excluded. Claims for damages are in any event limited to a three-year period, counted from shipment.

9.3. The parties to a contract also mutually renounce all claims for any damages covered by an insurance held by the damaged party. This renunciation will not extend to damages inflicted by intent or gross negligence or if the insurer would be exempt from indemnification as a consequence of such renunciation.

9.4. Locking mechanisms or safe deposits provided by VOGLAUER will not constitute theft or break-in protection so that claims for damages resulting from these are excluded. A possibly required anti-theft device will therefore be acquired by the customer at his or her own cost and risk; VOGLAUER will not be held liable for locked items.

**10. Payment**

10.1. Invoices for the delivery of goods will be sent by email and are payable according to the stipulations of the individual contract. Unless stipulated otherwise, the customer will pay one third of the total amount quoted in the order acknowledgement as a down payment promptly upon order placement, one third two weeks prior to readiness for shipment and the remaining amount immediately upon receipt of the final invoice without discount. As far as there is no written agreement between the parties to a contract with regards to terms of payment, the amounts invoiced are payable directly upon receipt of the invoices without discounts. Bills of exchange or cheques will be accepted only on the grounds of separate written agreement and solely as payment. Discount and exchange expenses will be payable immediately by the customer. The customer recognizes that VOGLAUER field staff are not entitled to collect payment.

10.2. In case of delayed payment, interest for delay amounting to 8% above the then current base-lending rate will be charged. Set-off by the customer is ruled out except with receivables accepted in writing by

VOGLAUER or ascertained in a legally binding manner.

10.3. If a customer cannot continue orderly business operations or forced sale of collaterals is in progress, if an act of protest is ongoing or delay or stop of payments is prevailing or if the customer has filed in or out of courts for a settlement system or bankruptcy has been declared, whether successful or not, VOGLAUER has the right to declare all outstanding bills from the business relationship due immediately, even if bills or exchange or cheques have been accepted or payment by instalments has been agreed. This also applies if and when the customer is late with payment or other circumstances indicate towards a questionable credibility. Furthermore, VOGLAUER has in the above-mentioned cases the right to demand advance payment or securities, realize securities provided or withdraw from the contract, claiming damages for default of performance.

10.4. Customers do not have the right to withhold payment due to alleged deficiencies, except if such deficiencies and the withholdable amounts have been accepted in writing by VOGLAUER or ascertained by a legal court. Any cession of customer receivables against VOGLAUER to third parties as well as any cession of rights and obligations of the closed contract is prohibited without prior written consent by VOGLAUER.

**11. Reservation of Property Rights**

11.1. The goods delivered remain the sole property of VOGLAUER until fulfillment of all obligations of the customer, specifically full payment of the purchase price including all side costs and interest, dues, fees, etc.

11.2. Goods delivered for a particular building project, even if ordered, delivered and invoiced in tranches, are considered one coherent order. In such cases the reservation of property rights to all goods delivered will expire only when all payments resulting from the contracts therein have been made in full.

11.3. The customer has the right to sell goods delivered under this reservation of property rights only if they are dedicated goods for resale or after the reservation of property rights has expired or VOGLAUER expressly authorizes such sale. In case of resale of goods, the customer will cede all claims resulting from such sale to VOGLAUER. The customer has the obligation to make such cession recognizable by corresponding entries in his or her books and to disclose to VOGLAUER upon request the names of the debtors as well as to precisely specify the ceased receivables. The cession will be accepted by VOGLAUER. Any dues or taxes related to such cession are to be carried by the customer, who will indemnify VOGLAUER of claims resulting thereof. VOGLAUER retains the right to disclose the cession and to realize the receivables ceased directly.

11.4. The customer has the obligation to sufficiently cover the reserved goods by insurance against common risks such as elementary events and to provide proof of such cover to VOGLAUER upon request. The customer hereby cedes given insurance claims to VOGLAUER. The customer also has the obligation to store the goods according to instructions given by VOGLAUER and to the state of the art. The customer has the obligation to tend to the goods during the reservation of property rights.

11.5. The customer will immediately notify VOGLAUER of access to the goods under reservation of VOGLAUER property rights by third parties (execution or listing for execution, other court orders or enactments). The customer will support and assist VOGLAUER in legal attempts to protect VOGLAUER's rights to the property and carry all associated costs if the customer has inflicted the threat to reserved VOGLAUER property.

11.6. In case of connection or mingling of reserved VOGLAUER property with other goods, VOGLAUER will gain joint ownership in the resulting goods proportionally to the value of the reserved property with respect to the value of the other goods at the time of connection or mingling. In case of sale of the resulting matter, the customer will cede the aliquot sales price in the sense of the stipulation above to VOGLAUER.

**12. Intellectual Property**

Trade marks, representations and the associated sketches, plans and descriptions are the intellectual property of VOGLAUER and must not be copied or disclosed to third parties without prior written consent by VOGLAUER.

**13. Advertising**

It is accepted that objects furnished by VOGLAUER may be used by VOGLAUER for purposes of advertising (reference lists, brochures, press releases, etc.) quoting customer names and using pictures of the furnished objects. The customer grants VOGLAUER the right to take pictures of the furnished objects.

**14. Force Majeure**

Events of force majeure affecting VOGLAUER or any of VOGLAUER's suppliers constitute the right for VOGLAUER to suspend deliveries for the duration of the hampering circumstances plus a reasonable lead-time without such suspension constituting a delay or the right for customers to fully or partially withdraw from the contract.

Events of force majeure are, among other things: All effects of the forces of nature such as earthquake, lightning, frost, storm, flood; furthermore, war, legal action, enactments by local authorities, detention, transport disruption, export, import or transit bans, international payment restrictions, raw material shortage and power loss; furthermore, operational disruptions such as explosions, fire, strike, sabotage and all other events which could not be prevented other than by unreasonably high costs or means not economically justifiable.

**15. Data Privacy Assent**

The customer expressly agrees that collection, processing and use of personal data provided by the customer may be used by VOGLAUER for marketing purposes by installation of a customer data base and related activities. This assent specifically includes information transfer for purposes of advertising by fax, letter, email or any other method. This assent can be withdrawn by customers at all times with immediate effect for the future.

**16. Final Provisions**

16.1. All contracts closed by and with VOGLAUER as well as these terms and conditions are governed exclusively by Austrian law with the exclusion of the relegation norms and the UN convention on contract for the international sale of goods. All disputes arising directly or indirectly from contracts with VOGLAUER will be regulated at the appropriate court in the city of Salzburg, Austria. Place of performance for delivery and payment will be the principal office of VOGLAUER.

16.2. In case one or more of the stipulations herein or in a contract become invalid in full or in part, validity of the remaining stipulations will remain untouched. Fully or partly invalid stipulations will be considered replaced by provisions whose economical success approximates closest the original stipulation(s).

16.3. All changes or amendments of contracts between VOGLAUER and customers must be in writing, including the agreement to waive this stipulation. All declarations by VOGLAUER will only be legally binding if they are issued in writing by staff of the VOGLAUER principal office at Abtenau, Austria.



# VOGLAUER FURNITURE LINES



V-Solid / NEW 2015

- Dining
- Living



V-Alpin

- Dining
- Living
- Hall



V-Montana

- Dining
- Living
- Hall



V-Loft

- Dining
- Living



V-Vita

- Dining
- Living
- Hall



V-Soft

- Dining
- Living



V-Pur / NEW 2015

- Sleeping



V-Rivera

- Sleeping



V-Linea

- Sleeping

Request desired folders either by telephone or on our homepage.  
It will be a pleasure for us to send them to you for free.

Voglauer traders:

You would like further information about our business or product lines? If so, please visit us online [www.voglauer.com](http://www.voglauer.com).



Follow us on Facebook!  
Regular News from VOGLAUER.

Voglauer Möbelwerk Gschwandtner & Zwilling GmbH & Co KG  
A-5441 Abtenau / Salzburger Land | Tel. +43 6243 2700-0 | Fax DW-210  
Email: [office@voglauer.com](mailto:office@voglauer.com) | [www.voglauer.com](http://www.voglauer.com)